

CHAPTER

9

SOLUTIONS

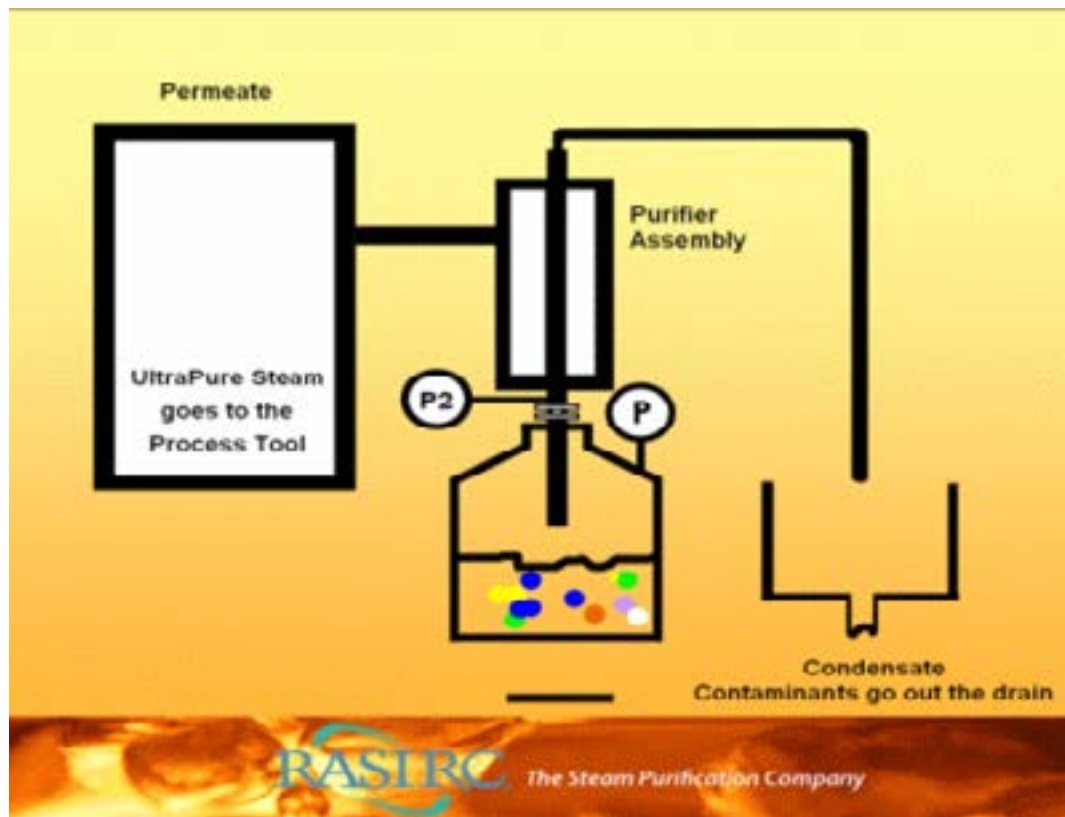
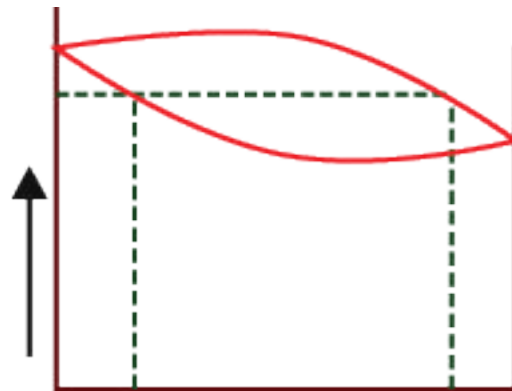

Animation 9.1: RAOULT'S LAW

Source & Credit: rasirc

9.0.0 CONCEPT OF A SOLUTION

Every sample of matter with uniform properties and a fixed composition is called a phase. For example, water at room temperature and normal pressure exists as a single liquid phase, that is, all the properties of water are uniform throughout this liquid phase. If a small amount of sugar is added to this sample of water, the sugar dissolves but the sample remains as a single liquid phase. However, the properties and composition of this new liquid phase, now the sugar solution, are different from those of pure water. As this solution of sugar in water is containing two substances (binary solution), so it is a mixture and since its properties are uniform, therefore, it is homogeneous in character.

A solution, on average, is a homogeneous mixture of two or more kinds of different molecular or ionic substances. The substance which is present in large quantity is called a solvent and the other component in small quantity is called a solute.

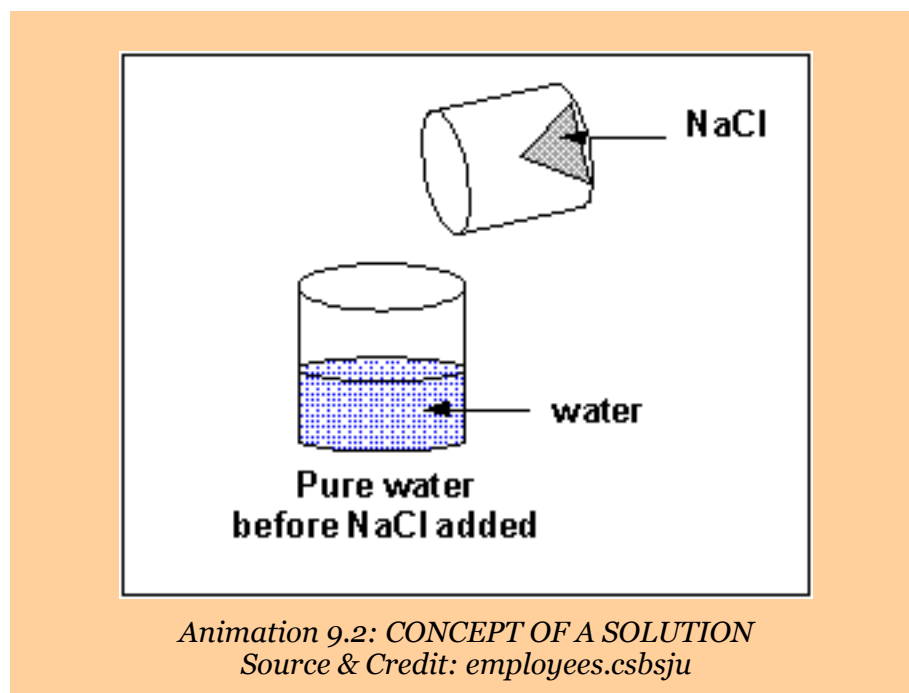

For a given solution, the amount of solute dissolved in a unit volume of solution (or a unit amount of solvent) is termed as the concentration of the solution. Solutions containing relatively lower concentrations of solute are called dilute solutions, whereas those containing relatively higher concentrations of solutes are called concentrated solutions.

9.1.0 CONCENTRATION UNITS OF SOLUTIONS

There are various types of concentration units of solutions. They are discussed as follows.

9.1.1 Percentage composition

The amounts of solute and solvent can be expressed in percentage composition by four different ways.

- Percentage weight/weight
- Percentage weight/volume
- Percentage volume/weight
- Percentage volume/volume

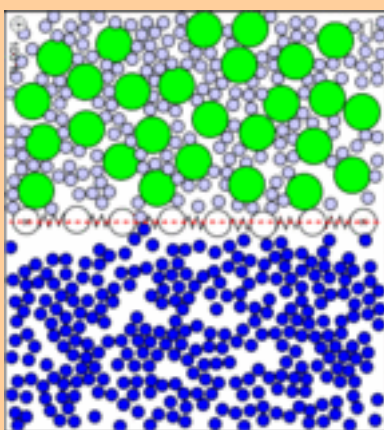

*Animation 9.3: CONCENTRATION UNITS OF SOLUTIONS
Source & Credit: chempaths.chemeddl*

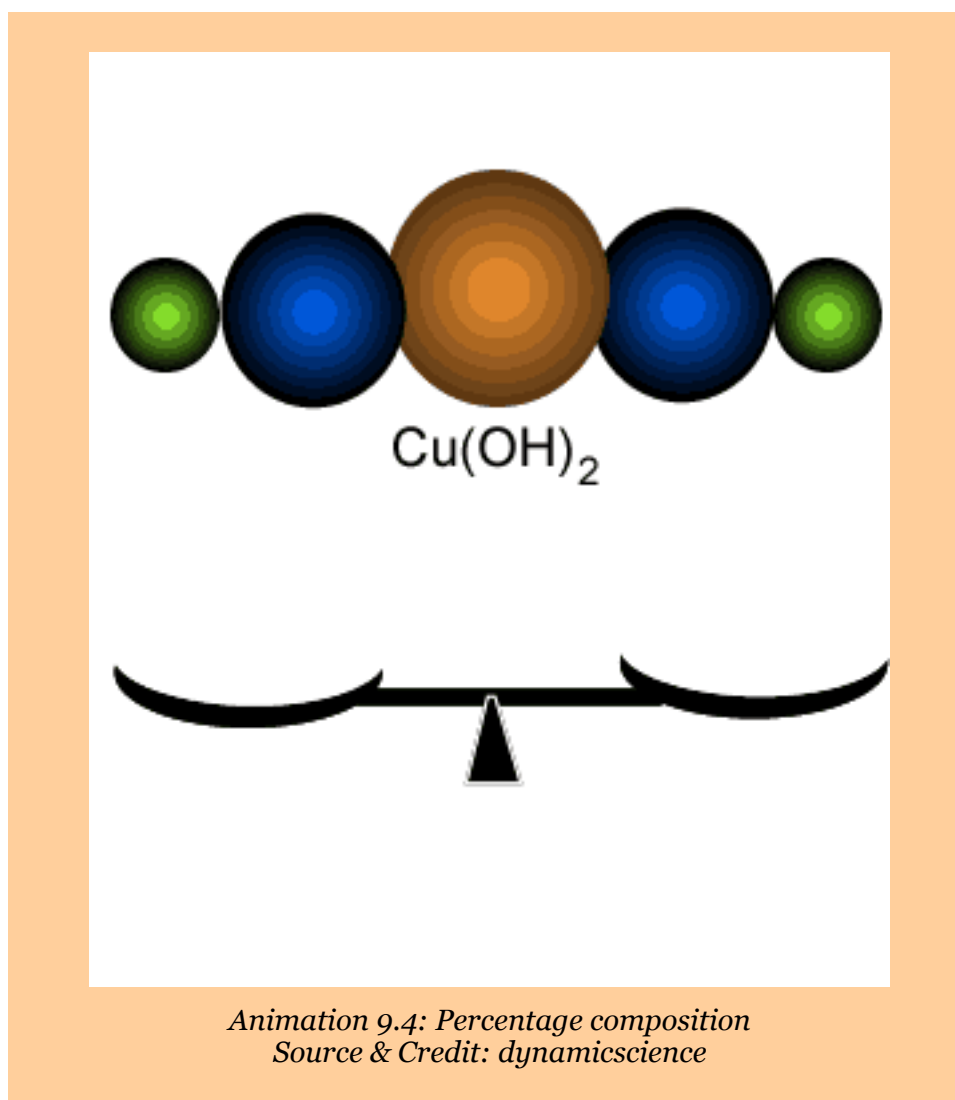

(a) Percentage weight / weight

It is the weight of a solute dissolved per 100 parts by weight of solution. 5% w/w sugar solution will contain 5 g of sugar dissolved in 100 g of solution in water. This solution contains 95 g of water.

$$\% \text{ by weight} = \frac{\text{Mass of solute}}{\text{Mass of solution}} \times 100$$

Example (1):

Calculate the percentage by weight of NaCl, if 2.0g of NaCl is dissolved in 20 g of water.

Solution:

$$\text{Weight of NaCl} = 2.0\text{g}$$

$$\text{Weight of solvent} = 20.0\text{g}$$

$$\text{Weight of solution} = 20+2 = 22\text{g}$$

$$\% \text{ of NaCl by weight} = \frac{2.0\text{g}}{22.0\text{g}} \times 100 = \boxed{9.09\%} \text{ Answer}$$

(b) Percentage Weight/Volume

It is the weight of a solute dissolved per 100 parts by volume of solution. 10 g of glucose dissolved in 100 cm³ of solution is 10% w/v solution of glucose. The quantity of the solvent is not exactly known. In such solutions, the total volume of the solution is under consideration.

(c) Percentage Volume /Weight

It is the number of cm³ of a solute dissolved per 100 g of the solution. If we dissolve 10 cm³ of alcohol in water and the total weight of the solution is 100 g, then it is 10% v/w solution of alcohol in water. In such type of solutions, we don't know the total volume of the solution.

(d) Percentage Volume / Volume

It is the volume of a solute dissolved per 100 cm³ of the solution. This unit of concentration is best applicable to the solutions of liquids in liquids. A 12 % alcohol beverage is 12 cm³ of alcohol per 100 cm³ of solution. In such solutions, the total volume of the solution may not be necessarily equal to the sum of volumes of solute and the solvent.

9.1.2 Molarity (M)

Molarity is the number of moles of solute dissolved per dm³ of the solution. To prepare one molar solution of glucose in water, we take 180 g of glucose and add sufficient water to make the total volume 1 dm³ (1litre) in a measuring flask.

In case of one molar solution of sucrose, 342 g of sucrose are dissolved in water to make it 1 dm³. Since the volume of 342 g of sucrose is greater than 180 g of glucose so the volume of water in 1 molar sucrose solution is less than that of 1 molar glucose solution. Anyhow, to calculate the volume of the solvent, we need to know the density of the solute. Following formula is used to prepare the solution of any molarity.

M	<input type="text" value="0"/>	mol/L	%	<input type="text" value="0"/>	w/w
m	<input type="text" value="0"/>	mol/kg	%	<input type="text" value="0"/>	w/v
x	<input type="text" value="0"/>		d	<input type="text" value="0.9991"/>	g/mL

Animation 9.5: Molarity (symbol, M)
Source & Credit: chembuddy

$$\text{Molarity}(M) = \frac{\text{Mass of solute}}{\text{Molar mass of solute}} \times \frac{1}{\text{Volume of solution (dm}^3\text{)}}$$

or

$$\text{Molarity}(M) = \frac{\text{Number of moles of solute}}{\text{Volume of solution (dm}^3\text{)}}$$

Examples (2):

Calculate the molarity of a solution containing 20.7 g of K₂CO₃ dissolved in 500 cm³ of the given solution.

Solution:

$$\text{Mass of K}_2\text{CO}_3 = 20.7\text{g}$$

$$\text{Molar mass of K}_2\text{CO}_3 = 138\text{g mol}^{-1}$$

$$\text{volume of solution} = 500\text{cm}^3 = 0.5\text{dm}^3$$

Formula:

$$\text{Molarity} = \frac{\text{Mass of solute}}{\text{Molar mass of solute}} \times \frac{1}{\text{Volume of solution in dm}^3}$$

$$\text{Molarity} = \frac{20.7\text{g}}{138\text{g mol}^{-1}} \times \frac{1}{0.5\text{dm}^3} = 0.3\text{mol dm}^{-3} = \boxed{0.3\text{mol dm}^{-3}} \text{ Answer}$$

9.1.3 Molality (m)

Molality is the number of moles of solute in 1000 g (1 kg) of the solvent. In order to prepare molal solutions, we don't have to take any flask. 180 g of glucose when dissolved in 1000 g of water gives one molal solution of glucose. The total mass of the solution is 1180 g. We don't know the volume of the solution. In order to know the volume we need the density of the solution. For one molal sucrose solution, 342 g of sucrose are dissolved in 1000 g of H₂O.

So, one molal solution of different solutes in water have their own masses and volumes. In order to get the molality of any solution, we use the following equation.

$$\text{Molality(m)} = \frac{\text{Mass of solute}}{\text{Molar mass of solute}} \times \frac{1}{\text{Mass of solvent in kg}}$$

or

$$\text{Molality(m)} = \frac{\text{Number of moles of solute}}{\text{Mass of solvent in kg}}$$

Example (3):

What is the molality of a solution prepared by dissolving 5g of toluene (C₇H₈) in 250g of benzene.

Solution:

Mass of toluene = 5g

Mass of benzene = 250g = 0.25kg

Molar mass of toluene = 12x7+1x8=92

Formula used

$$\text{Molality(m)} = \frac{\text{Mass of solute}}{\text{Molar mass of solute}} \times \frac{1}{\text{Mass of solvent in kg}}$$

$$\begin{aligned}\text{Molality}(m) &= \frac{5\text{g}}{92\text{g mol}^{-1}} \times \frac{1}{0.250\text{ kg}} \\ &= \frac{5}{92 \times 0.25} \text{mol kg}^{-1} = \boxed{0.217\text{mol kg}^{-1}} \text{ Answer} \\ &= 0.217\text{m}\end{aligned}$$

The molality of a solution is indirect expression of the ratio of the moles of the solute to the moles of the solvent. The molal aqueous solution of a solute say glucose or NaOH is dilute in comparison to its molar solution. The reason is that in molal solution the quantity of the solvent is comparatively greater.

The value of concentration given in the units of molality does not change with temperature but that of molarity does. The reason is that the volume of liquids are affected by the variation in temperature.

9.1.4. Mole Fraction (x)

This unit of concentration may be for any type, of solution i.e. gas in gas, liquid in liquid or solid in liquid, etc. This unit is also applicable to a solution having more than two components.

The mole fraction of any component in a mixture is the ratio of the number of moles of it to the total number of moles of all the components present.

Let there be three components A, B, C making a solution. The number of moles are n_a , n_b , n_c respectively. If the mole fraction of A, B and C are denoted by x_a , x_b , x_c respectively, Then,

$$X_A = \frac{n_A}{n_A + n_B + n_C}$$

$$X_B = \frac{n_B}{n_A + n_B + n_C}$$

$$X_C = \frac{n_C}{n_A + n_B + n_C}$$

The sum of the mole fractions of all the components of a solution must be equal to one. There are no formal units of mole fraction. Anyhow, we sometimes multiply mole fraction by 100 to get mole percent.

Example (4):

Calculate the mole fraction and mole percent of each component in a solution having 92 g of ethyl alcohol, 96 g of methyl alcohol and 90 g of water.

Solution:

First of all get the number of moles of each component.

$$\text{Number of moles of the substance} = \frac{\text{Mass in grams of the substance}}{\text{Molecular mass in grams}}$$

$$\text{Molar mass of ethyl alcohol (C}_2\text{H}_5\text{OH)} = 46 \text{ gmol}^{-1}$$

$$\text{Number of moles of ethyl alcohol} = \frac{92\text{g}}{46 \text{ gmol}^{-1}} = 2 \text{ mol}$$

$$\text{Molar mass of methyl alcohol (CH}_3\text{OH)} = 32 \text{ gmol}^{-1}$$

$$\text{Number of moles of methyl alcohol} = \frac{96\text{g}}{32 \text{ gmol}^{-1}} = 3 \text{ mol}$$

$$\text{Molar mass of water (H}_2\text{O)} = 18 \text{ gmol}^{-1}$$

$$\text{Number of moles of water} = \frac{90\text{g}}{18 \text{ gmol}^{-1}} = 5 \text{ mol}$$

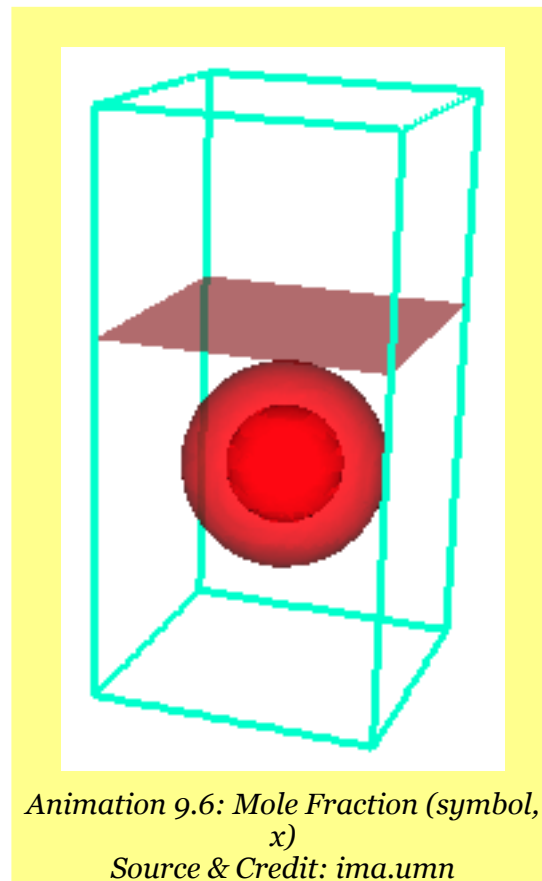

The mole fraction of any components is ratio of its moles to total number of moles.

$$X_{\text{ethyl alcohol}} = \frac{2}{2+3+5} = \frac{2}{10} = \boxed{0.2} \text{ Answer}$$

$$X_{\text{methyl alcohol}} = \frac{3}{2+3+5} = \frac{3}{10} = \boxed{0.3} \text{ Answer}$$

$$X_{\text{H}_2\text{O}} = \frac{5}{2+3+5} = \frac{5}{10} = \boxed{0.5} \text{ Answer}$$

Now, multiply the mole fractions with 100, to get mole percent.

$$\text{Moles \% of ethyl alcohol} = 0.2 \times 100 = \boxed{20} \text{ Answer}$$

$$\text{Moles \% of methyl alcohol} = 0.3 \times 100 = \boxed{30} \text{ Answer}$$

$$\text{Moles \% of H}_2\text{O} = 0.5 \times 100 = \boxed{50} \text{ Answer}$$

In the case of mixture of gases, one can determine the mole fraction from the partial pressure data of the mixture. Hence

$$X_A = \frac{p_A}{p_A + p_B + p_C}, \quad X_B = \frac{p_B}{p_A + p_B + p_C}, \quad X_C = \frac{p_C}{p_A + p_B + p_C}$$

Where p_a , p_b , p_c are the partial pressures of various gases in the mixture.

Generally, we can say that

$$\text{Mole fraction of any gas} = \frac{\text{Partial pressure of that gas}}{\text{Total pressure of the mixture of gases}}$$

9.1.5. Parts Per Million (ppm)

It is defined as the number of parts (by weight or volume) of a solute per million parts (by weight or volume) of the solution.

This unit is used for very low concentrations of solutions, e.g. to express the impurities of substances in water.

$$\text{Parts per million (ppm)} = \frac{\text{Mass of solute}}{\text{Mass of solution}} \times 10^6$$

Example (5):

Sea water has 5.65×10^{-3} g of dissolved oxygen in one kg of water. Calculate the concentration of oxygen in sea water in parts per million

$$\text{ppm of oxygen in sea water} = \frac{5.65 \times 10^{-3} \text{ g}}{1000 \text{ g}} \times 10^6 = \boxed{5.65 \text{ ppm}} \text{ Answer}$$

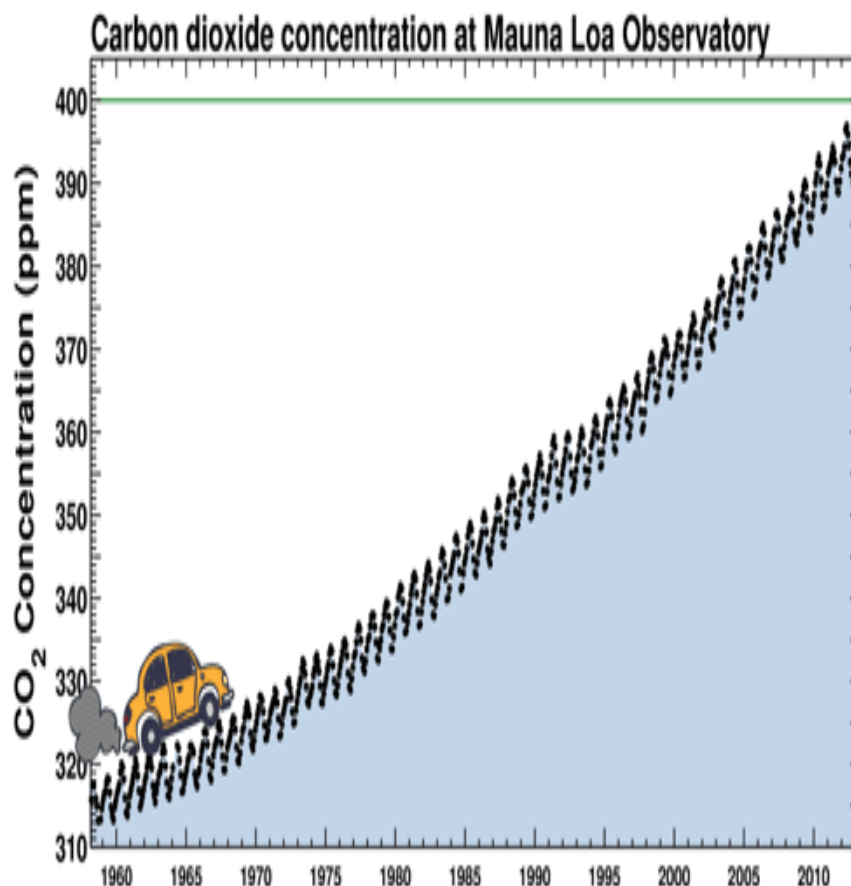

*Animation 9.7: Parts Per Million (symbol, p p m)
Source & Credit: media.tumblr*

9.1.6 Interconversion of Various Concentration Units of Solutions

Sometimes, we get prepared solutions from the chemical supply houses. For example, we are working with a solution whose molarity is given by the supplier, but we need to know its molality or w/w percentage. For such purpose, we need to convert one unit of concentration into other. These conversions are usually done if we know the formula masses and the densities of the solutes or solutions. Following table shows the five important chemicals whose w/w%, molarities and densities are given.

One should be able to interconvert these concentration units into each other and moreover to molalities and mole fractions for laboratory work. Let us do some calculations in this respect.

Name of Acid	% (w/w)	Molarity (M dm ⁻³)	Density (gcm ⁻³)
H ₂ SO ₄	98%	18	1.84
H ₃ PO ₄	85.5%	4.8	1.70
HNO ₃	70.4%	15.9	1.42
HCl	37.2%	12.1	1.19
CH ₃ COOH	99.8%	17.4	1.05

Example (6):

Calculate the molality of 8% w/w NaCl solution.

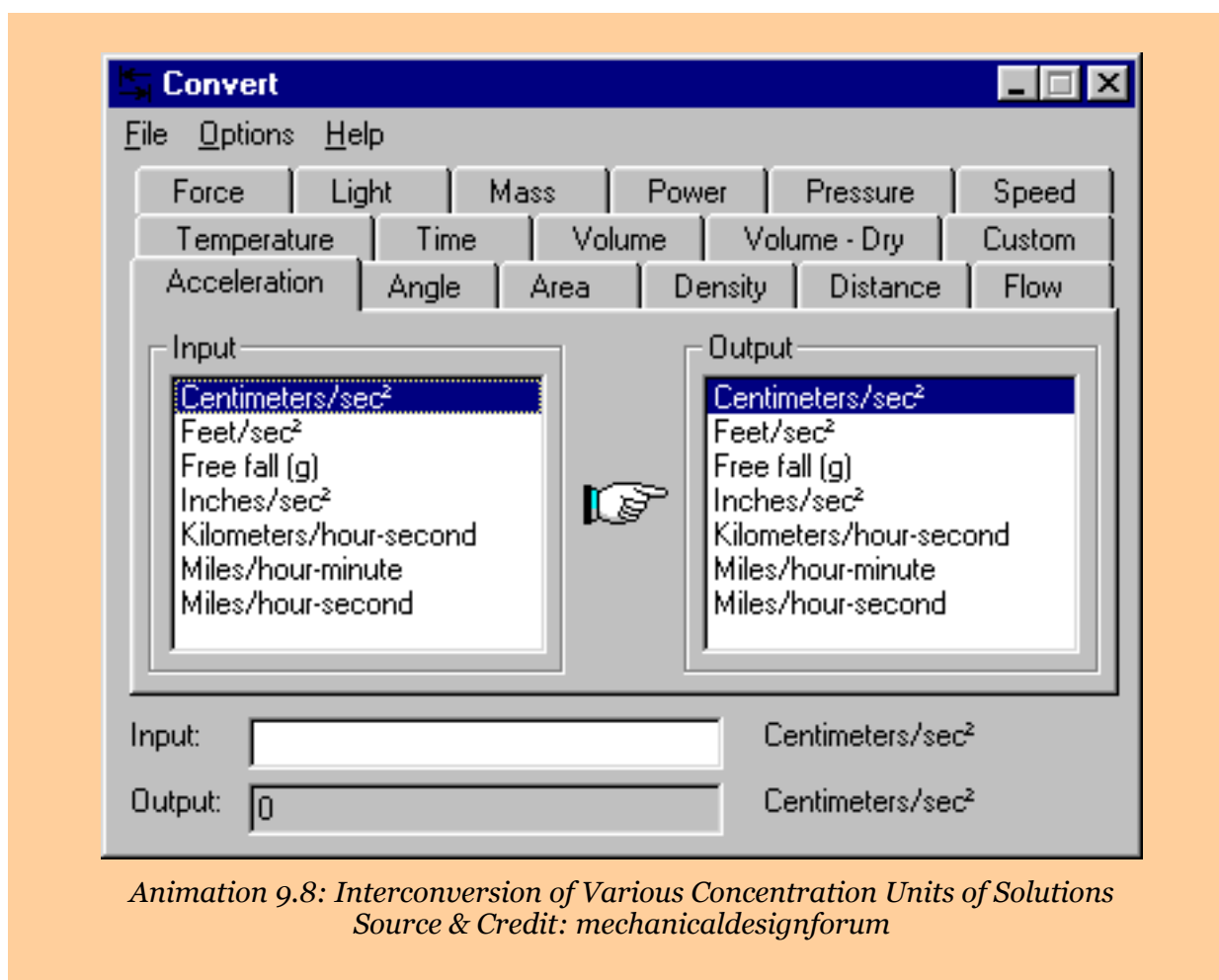

Animation 9.8: Interconversion of Various Concentration Units of Solutions
Source & Credit: mechanicaldesignforum

It means that 0.1367 moles of NaCl is dissolved in 0.092 kg of water.

$$\begin{aligned} \text{Molality (m)} &= \frac{\text{Number of moles of solute}}{\text{Mass of solvent in kg}} = \frac{0.1367 \text{ moles}}{0.092 \text{ kg}} \\ &= \boxed{1.487 \text{ m}} \text{ Answer} \end{aligned}$$

The given solution is 1.487 molal.

Example (7):

Hydrochloric acid available in the laboratory is 36% (w/w). The density of HCl solution is 1.19 g cm^{-3} . Determine the molarity of HCl solution.

Solution:

36% (w/w) HCl solution means that 36g of HCl dissolved in 100g of solution.

$$\text{Mass of HCl} = 36\text{g}$$

$$\text{Mass of solution} = 100\text{g}$$

In case of molarity, the final volume of solution is 1000 cm^3 . Convert this volume into mass, by using density of 1.19 g cm^{-3} .

$$\text{Mass of } 1000\text{cm}^3 \text{ of HCl solution} = 1000 \times 1.19 = 1190\text{g}$$

$$\text{Since,} \quad (\text{Mass} = \text{volume} \times \text{density})$$

$$100\text{g of solution has HCl} = 36\text{g}$$

$$\text{so, mass of HCl in } 1190\text{g of solution} = \frac{1190 \times 36}{100} = 428.4\text{g}$$

$$\text{Molar mass of HCl} = 36.5 \text{ g mol}^{-1}$$

$$\text{Number of moles of HCl, in } 428.4\text{g of HCl} = \frac{428.4\text{g}}{36.5\text{g mol}^{-1}} = 11.73$$

So, 1000 cm^3 solution of HCl has 11.73 moles of HCl

Hence, molarity of HCl = $11.73 \text{ mol dm}^{-3}$ Answer

Example (8):

9.2 molar HClO_4 is available in the market. The density of this solution is 1.54 g cm^{-3} . What is the percentage by weight of HClO_4 .

Solution:

$$\text{Molarity of HClO}_4 = 9.2 \text{ g moles dm}^{-3}$$

$$\text{Density of solution} = 1.54 \text{ gcm}^{-3}$$

Let us calculate the mass of solution which is 1 dm^3 in volume and has 9.2 moles of HClO_4 in it.

$$\begin{aligned} \text{Since, Mass} &= \text{volume} \times \text{density} \\ \text{Mass of } 1000 \text{ cm}^3 \text{ solution} &= 1000 \text{ cm}^3 \times 1.54 \text{ gcm}^{-3} = 1540 \text{ g} \end{aligned}$$

$$\text{Molar mass of HClO}_4 = 100.5 \text{ gm mol}^{-1}$$

9.2 moles of HClO_4 , can be converted to its mass

$$\text{Mass of HClO}_4 = 100.5 \text{ g mol}^{-1} \times 9.2 \text{ mol} = 924.6 \text{ g}$$

$$\text{Mass of H}_2\text{O} = \text{mass of solution} - \text{mass of HClO}_4 = 1540 - 924.6 = 615.4 \text{ g}$$

$$\% \text{ of HClO}_4 \text{ by weight} = \frac{\text{mass of HClO}_4}{\text{mass of solution}} \times 100 = \frac{924.6}{1540} \times 100 = 60.04$$

$$\% \text{ of H}_2\text{O by weight} = 100 - \text{mass of HClO}_4 = 100 - 60.04 = \boxed{39.96} \text{ Answer}$$

9.2 TYPES OF SOLUTIONS

Most commonly, we come across solutions, where solute is a solid and the solvent is a liquid. As a matter of fact, all the three states of matter i.e. solid, liquid or gas can act as solute or solvent. Examples for nine possible types of solution are given in Table (9.2).

Table (9.2) Common types and examples of solutions

State of Solute	State of Solvent	Example
Gas	Gas	Air
Gas	Liquid	O ₂ in water, CO ₂ in water.
Gas	Solid	H ₂ adsorbed by palladium
Liquid	Gas	Mist, fog, clouds, liquid air pollutants.
Liquid	Liquid	Alcohol in water, milk, benzene in toluene.
Liquid	Solid	Mercury in silver, butter, cheese.
Solid	Liquid	Sugar in water, jellies, paints.
Solid	Gas	Dust particles in smoke.
Solid	Solid	Metal alloys pearls, opals, carbon in iron (steel).

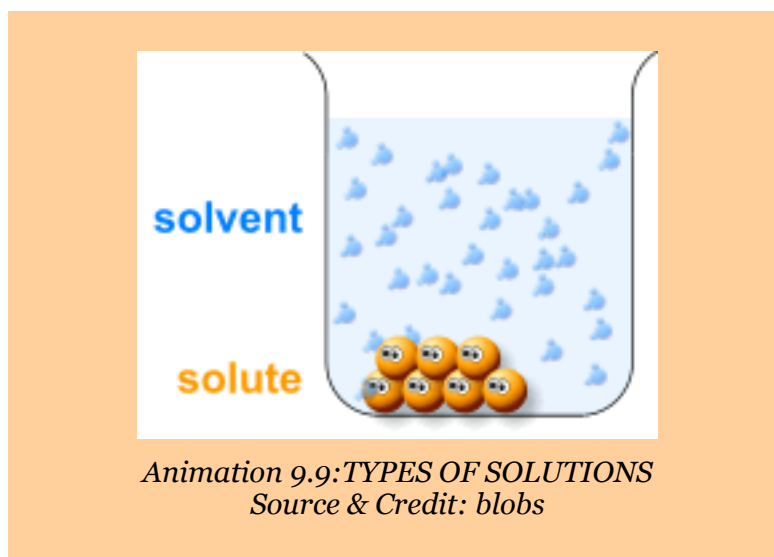

9.2.1 Solutions of Solids in Liquids

When a solid comes in contact with a suitable liquid, it dissolves forming a solution i.e. a homogeneous mixture. This process of dissolution can be explained in terms of attraction between the particles of a solute and that of a solvent. The molecules or ions in solids are arranged in such a regular pattern that the inter-molecular or inter-ionic forces are at a maximum.

The process of dissolution is to overcome these forces of attraction holding together the solute molecules or ions in the crystal lattice, by the solute-solvent forces. In molecular crystals, the inter-molecular forces of attraction are either dipole-dipole or London dispersion type. These forces are relatively weak and can easily be overcome. Hence, non-polar or less polar molecular crystals usually dissolve in non-polar solvents like benzene.

In the crystal lattice, the inter-molecular or inter-ionic forces of attraction between highly polar molecules or ions are quite strong, hence the polar solids fail to dissolve in nonpolar solvents. These strong electrostatic forces cannot be overcome or shattered by the weak solute-solvent attractions. Take the case of cane sugar. Due to hydrogen bonding, it has tightly bound molecules, so it will not be dissolved by solvents like kerosene oil, petrol, benzene, etc. It will be dissolved readily in water, because water attracts sugar molecules almost in the same way as the sugar molecules attract one another.

The inter-ionic forces of attraction are very strong in ionic solids so, equally strong polar solvents are needed to dissolve them. Such solids cannot be dissolved by moderately polar solvents e.g. acetone. A moderately polar solvent, fails to dissolve sodium chloride, which is an ionic solid.

Thus the solubility principle is that "like dissolves like".

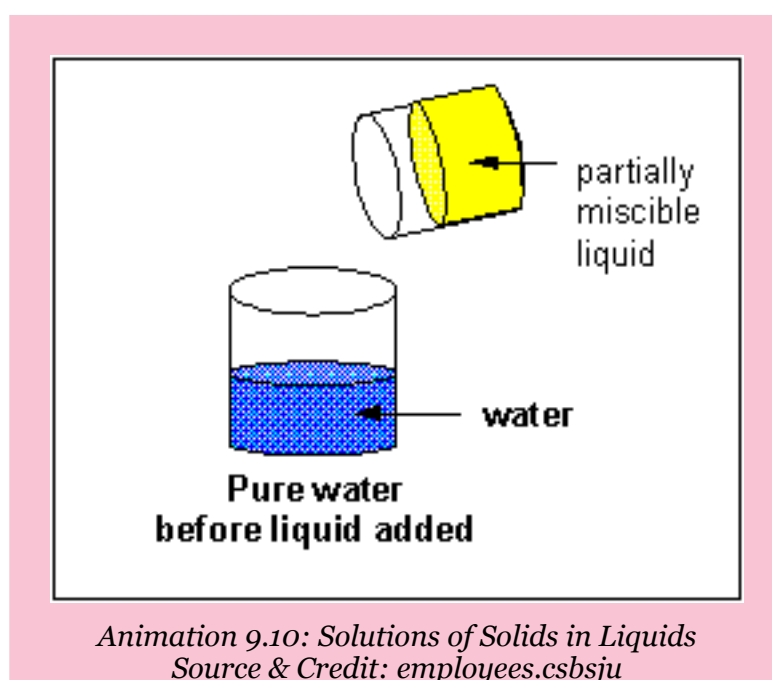

*Animation 9.10: Solutions of Solids in Liquids
Source & Credit: employees.csbsju*

9.2.2 Solutions of Liquids in Liquids

The solutions of liquids in liquids may be divided into three classes.

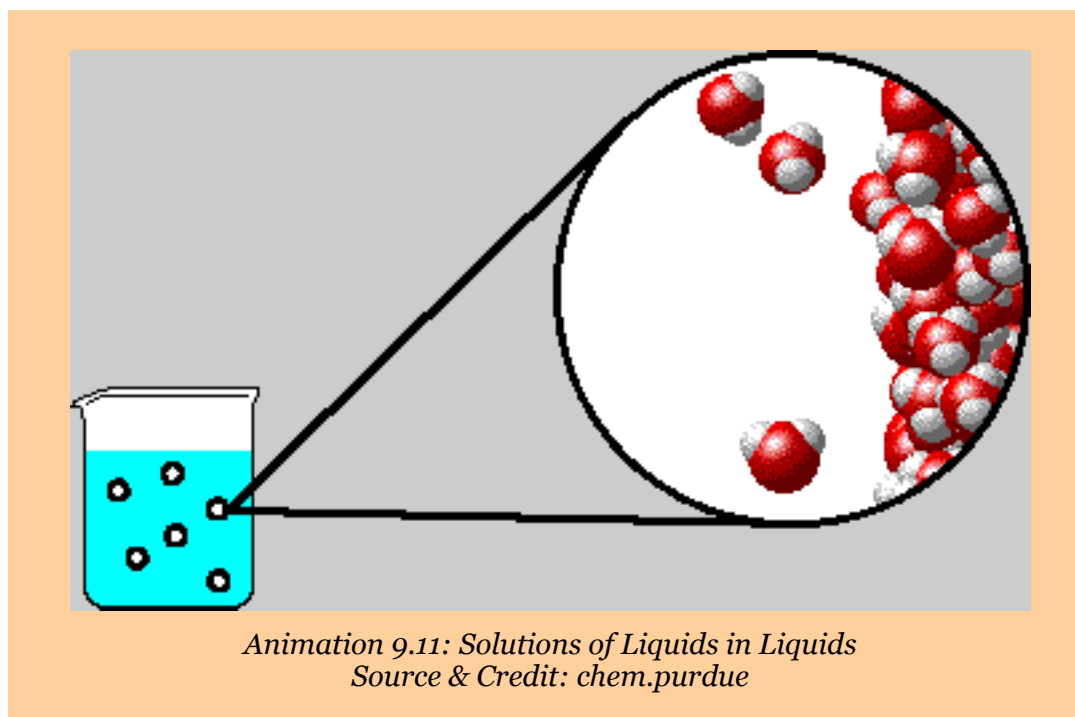

(i) Completely Miscible Liquids

Liquids like alcohol and water or alcohol and ether mix in all proportions. However, the properties of such solutions are not strictly additive. Generally, the volume decreases on mixing but in some cases it increases. Heat may be evolved or absorbed during the formation of such solutions. These types of solutions can usually be separated by fractional distillation.

(ii) Partially Miscible Liquids

A large number of liquids are known which dissolve into one another up to a limited extent. For example, ether $C_2H_5-O-C_2H_5$ dissolves water to the extent of about 1.2 % and water dissolves ether up to the extent of about 6.5%.

As the mutual solubilities are limited, the liquids are only partially miscible. On shaking equal volumes of water and ether, two layers are formed. Each liquid layer is a saturated solution of the other liquid. Such solutions are called conjugate solutions. The mutual solubility of these conjugate solutions is affected by temperature changes. Typical examples of such systems are:

- Phenol-water system
- Triethylamine-water system
- Nicotine-water system

Phenol-Water System ($\text{H}_2\text{O} + \text{C}_6\text{H}_5\text{OH}$)

The example of phenol in water is interesting. If equal volumes of water and phenol are mixed together, they show partial miscibility. It has been observed that around room temperature, phenol will dissolve in a lot of water giving us the upper layer and water will dissolve in a lot of phenol giving us the lower layer.

At 25°C the upper layer is 5% solution of phenol in water and the lower layer is 30% water in phenol. These two solutions are conjugate solutions to each other. The lower layer has a greater density due to greater percentage of phenol. Water acts as a solute in the lower layer while phenol is a solute in the upper layer. When the temperature of water-phenol system is increased, the compositions of both layers change. Water starts travelling from upper to the lower layer and phenol travels from lower to the upper layer.

When the temperature of this system approaches 65.9°C , a homogeneous mixture of two components is obtained. This homogeneous mixture contains 34% phenol and 66% water. **The temperature of 65.9°C at which two conjugate solutions merge into one another, is called critical solution temperature or upper consolute temperature.** Some other partially miscible pairs of liquids have their own consolute temperatures with definite compositions.

For example, water-aniline system has a single layer at 167.0°C with 15% water. Methanol-cyclohexane system has consolute temperature of 49.1°C with 29% methanol.

(iii) Liquids Practically Immiscible

Those liquids which do not dissolve into each other in any proportion are immiscible.

Examples: (i) Water and benzene ($\text{H}_2\text{O} + \text{C}_6\text{H}_6$)

(ii) Water and carbon disulphide ($\text{H}_2\text{O} + \text{CS}_2$)

9.3.0 IDEAL AND NON-IDEAL SOLUTIONS

When two or more than two liquid substances are mixed, the solutions may be ideal or non-ideal. To distinguish between such solutions we look at the following aspects:-

- i. If the forces of interactions between the molecules of different components are same as when they were in the pure state, they are ideal solutions, otherwise non-ideal.
- ii. If the volume of solution is not equal to the sum of the individual volumes of the components, the solution is non-ideal.
- iii. Ideal solutions have zero enthalpy change as their heat of solution.
- iv. If the solutions obey Raoult's law, then they are ideal. This is one of the best criterion for checking the ideality of a solution

Let us first study, the Raoult's law and then try to understand ideality of solutions, the process of fractional distillation and the formation of azeotropes.

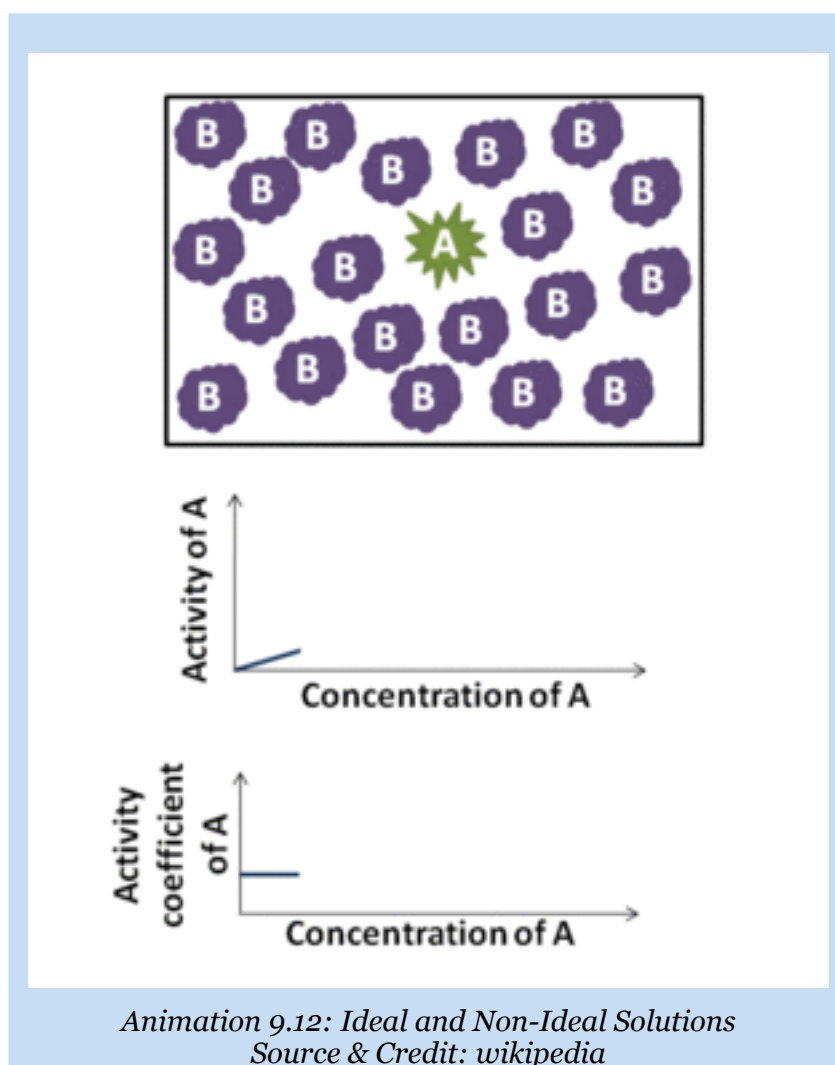

9.3.1 RAOULT'S LAW

Raoult's law can be defined in these ways:

The vapour pressure of a solvent above a solution is equal to the product of the vapour pressure of pure solvent and the mole fraction of solvent in solution.

Mathematically, it can be written in equation form as follows:

$$p = p^\circ x_1 \quad \dots\dots\dots (1)$$

Where p is the vapour pressure of solvent in the solution, p° is the vapour pressure of pure solvent and x_1 is the mole fraction of solvent.

We also known that

$$X_1 + X_2 = 1 \quad (x_2 \text{ is the mole fraction of solute})$$

$$\text{or} \quad X_1 = 1 - X_2$$

Putting the value of x_1 in equation (1)

$$p = p^\circ(1 - X_2)$$

$$\text{or} \quad p = p^\circ - p^\circ X_2$$

$$\text{or} \quad p^\circ - p = p^\circ X_2$$

$$\text{or} \quad \Delta p = p^\circ X_2 \quad \dots\dots\dots(2)$$

Equation (2) gives another definition of Raoult's law. "The lowering of vapour pressure is directly proportional to the mole of fraction of solute." Now rearrange equation (2) to get equation (3).

$$\frac{\Delta p}{p^\circ} = X_2 \quad \dots\dots\dots (3)$$

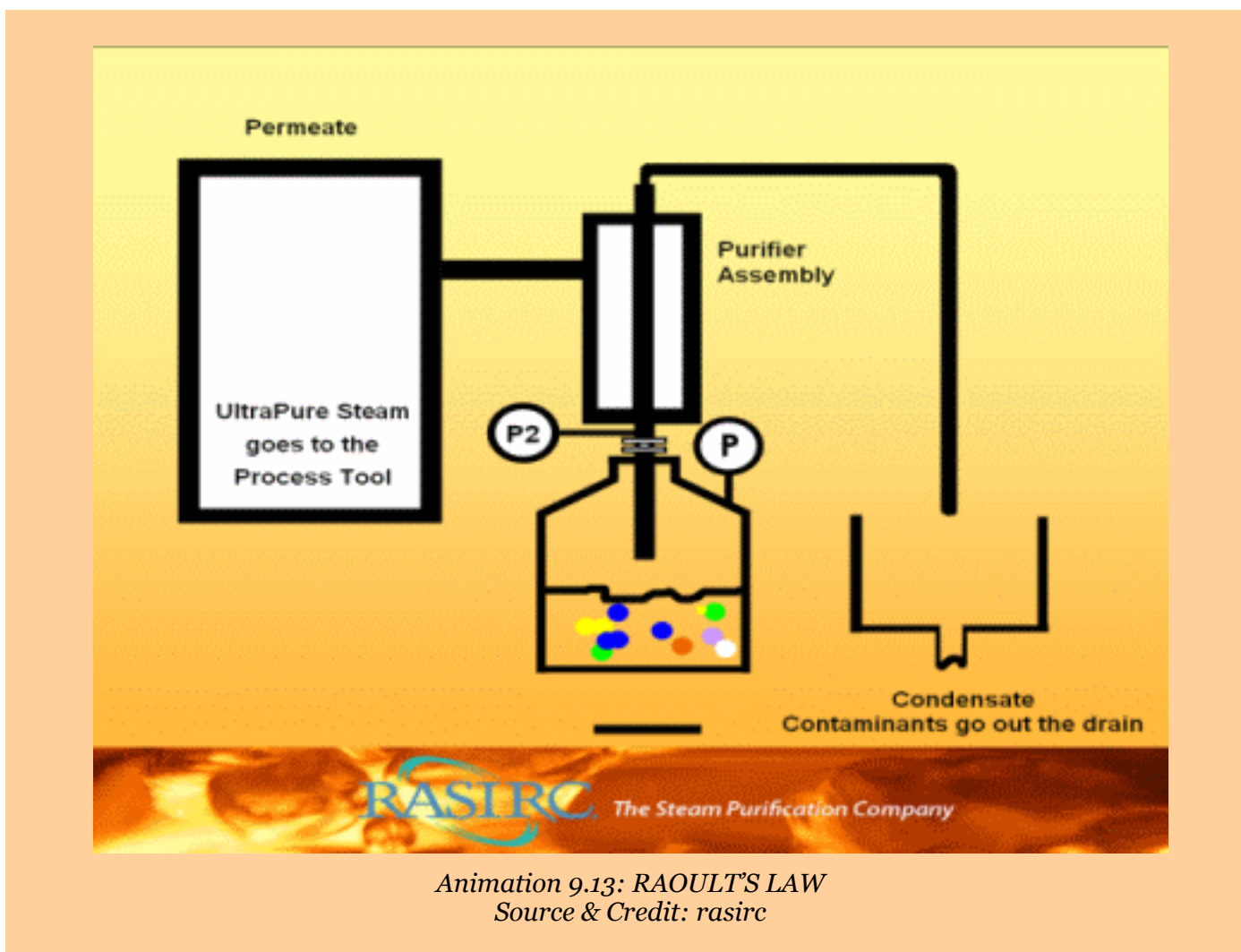

$\Delta p/p^\circ$ is called relative lowering of vapour pressure and it is more important than actual lowering of vapour pressure (Δp). The equation (3) gives us another definition of Raoult's law. "The relative lowering of vapour pressure is equal to the mole fraction of solute".

The relative lowering of vapour pressure:

- (i) is independent of the temperature
- (ii) depends upon the concentration of solute.
- (iii) is constant when equimolecular proportions of different solutes are dissolved in the same mass of same solvent.

Example (9):

The vapour pressure of water at 30° C is 28.4 torr. Calculate the vapour pressure of a solution containing 70g of cane sugar ($C_{12}H_{22}O_{11}$) in 1000g of water at the same temperature. Also calculate the lowering of vapour pressure.

Solution:

Mass of cane sugar dissolved	=70g
Molar mass of cane sugar	= 342 g mole ⁻¹
Number of moles of a compound	= $\frac{\text{mass}}{\text{molar mass}}$
Number of moles of sugar, $C_{12}H_{22}O_{11}$ (n_2)	= $\frac{70g}{342g/mol} = 0.20$
Mass of H ₂ O in solution	=1000g
Number of moles of water, H ₂ O (n_1)	= $\frac{1000g}{18.02g/mol} = 55.49$
Total number of moles	= 0.20 + 55.49 = 55.69
Mole fraction of sugar, $C_{12}H_{22}O_{11}$ (x_2)	= $\frac{n_2}{n_1+n_2} = \frac{0.2}{55.69} = 0.0036$
Mole fraction of water, H ₂ O (x_1)	= $\frac{n_1}{n_1+n_2} = \frac{55.49}{55.69} = 0.9964$
Vapour pressure of pure water	=28.4 torr
Applying the formula for vapour pressure of solution	$p = p^\circ X_1 = (28.4)(0.9964) = 28.29 \text{ torr}$
So, vapour pressure of solution	= 28.29 torr Answer
Lowering of vapour pressure, Δp	= 28.4 - 28.29 = 0.11 torr Answer

9.3.2 Raoult's Law (when both components are volatile)

Raoult's law can be applied to understand the relationship between mole fractions of two volatile components and their vapour pressures before making the solution and after making the solution. Consider two liquids 'A' and 'B' with vapour pressures p_A° and p_B° in the pure state at a given temperature. After making the solution, the vapour pressures of both liquids are changed. Let the vapour pressures of these liquids in solution state be p_A and p_B with their mole fractions x_A and x_B respectively.

Applying Raoult's law to both components

$$p_A = p_A^\circ x_A$$

$$p_B = p_B^\circ x_B$$

$$P_t = p_A + p_B = p_A^\circ x_A + p_B^\circ x_B \text{ where } P_t \text{ is total vapour pressure)}$$

since $x_A + x_B = 1$

$$x_B = 1 - x_A$$

$$P_t = p_A^\circ x_A + p_B^\circ (1 - x_A)$$

$$P_t = p_A^\circ x_A + p_B^\circ - p_B^\circ x_A$$

$$P_t = (p_A^\circ - p_B^\circ)x_A + p_B^\circ \quad \dots\dots\dots (4)$$

The component A is low boiling liquid and B is high boiling liquid. The vapour pressure of A is more than B at a given temperature.

Equation (4) is a equation of straight line If a graph is plotted between x_B or mole % of B on x-axis and P_t on y-axis, a straight line will be obtained Fig (9.1).

Only those pairs of liquids give straight lines which form ideal solutions. So, Raoult's law is one of the best criterion to judge whether a solution is ideal or not.

All the possible solutions of two components A and B have their vapour pressures on the straight line connecting p_A° with p_B° . All such solutions will be ideal. Each point on this straight line represents the vapour pressure of a solution, at a given temperature, with the corresponding contribution of both the components A and B. The two dotted lines represent the partial pressures of the individual components of solution. They show the increase of vapour pressure of a component with increase in its mole fraction in solution.

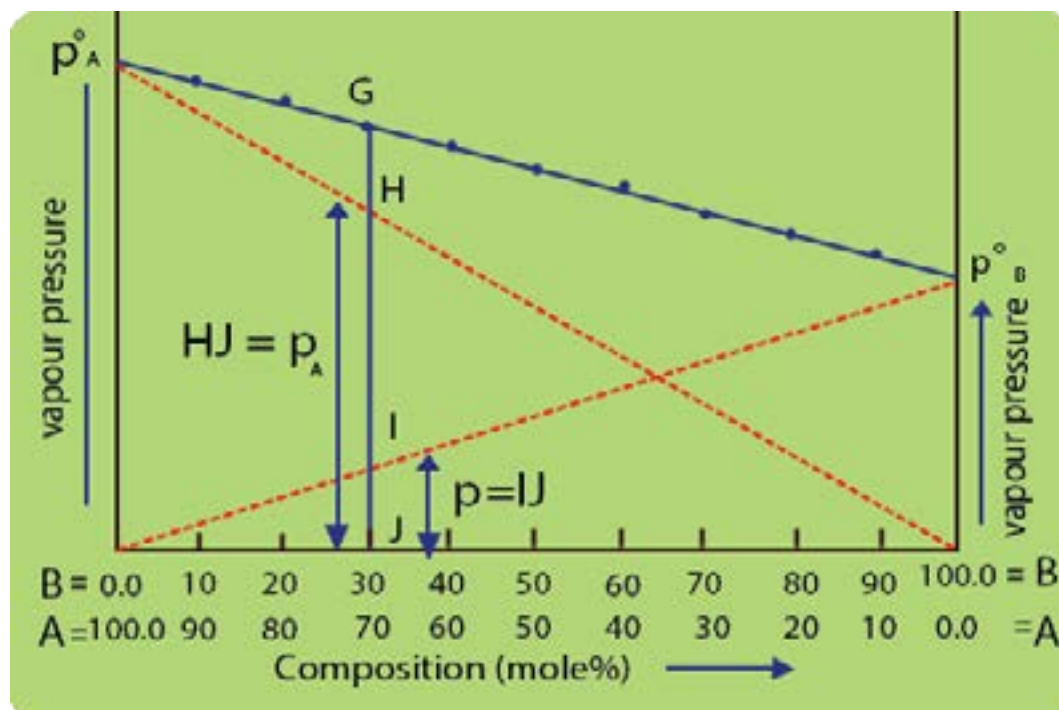

Fig. (9.1) Graph between composition and vapour pressure

In order to explain it, consider a point G on the straight line. This point represents the vapour pressure of solution with 30% moles contribution of the component B and 70% of component A.

Since, A is more volatile component, so its contribution towards the vapour pressure of solution is represented by p_A .

The contribution of the less volatile component B is represented by p_B . Similarly, we can calculate the relative contributions of A and B towards the total vapour pressure of solution by taking other points along the line joining p_A° to p_B° .

The total vapour pressure of the solution (P_t) corresponding to the point G will be equal to the sum of the vapour pressures of the individual components ($p_A + p_B$) as shown in the Fig. (9.1).

9.4 VAPOUR PRESSURES OF LIQUID -LIQUID SOLUTIONS

Binary mixtures of miscible liquids may be classified as (i) ideal (ii) non-ideal or real solutions.

The vapour pressures of solutions provides a simple picture about their behaviour. Let us discuss the vapour pressures of ideal and real solutions one by one.

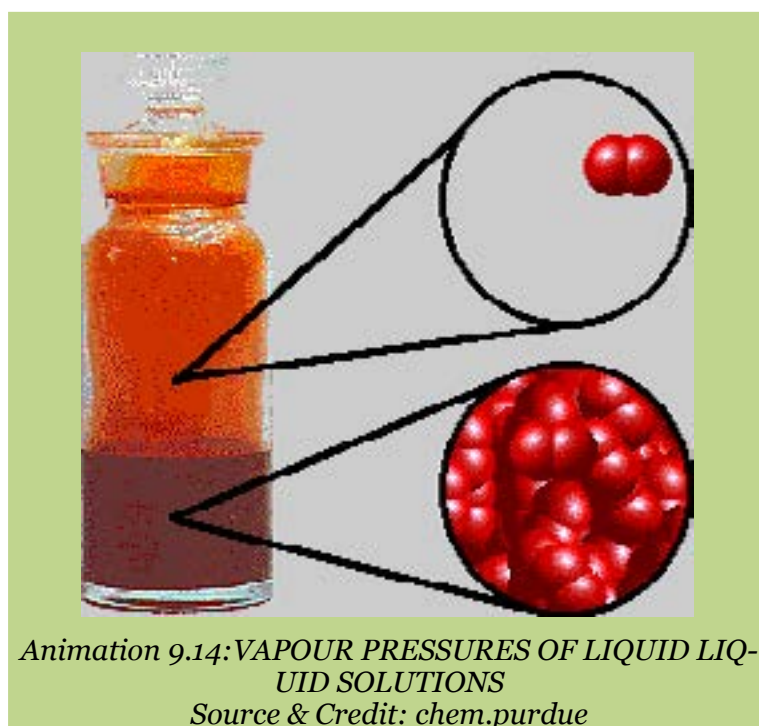

(i) Ideal solutions

An ideal solution is that which obeys Raoult's law. Some typical ideal solution forming liquid pairs are: benzene-toluene, benzene-ether, chlorobenzene-bromobenzene, ethyl iodide-ethyl bromide, etc.

Fractional Distillation of Ideal Mixture of Two Liquids

Let us have two liquids A and B which form a completely miscible solution. A is a more volatile component so its boiling point is less than B. If we have various solutions of these two components and a graph is plotted between compositions on x-axis and temperature on y-axis, then two curves are obtained as shown in the Fig. (9.2).

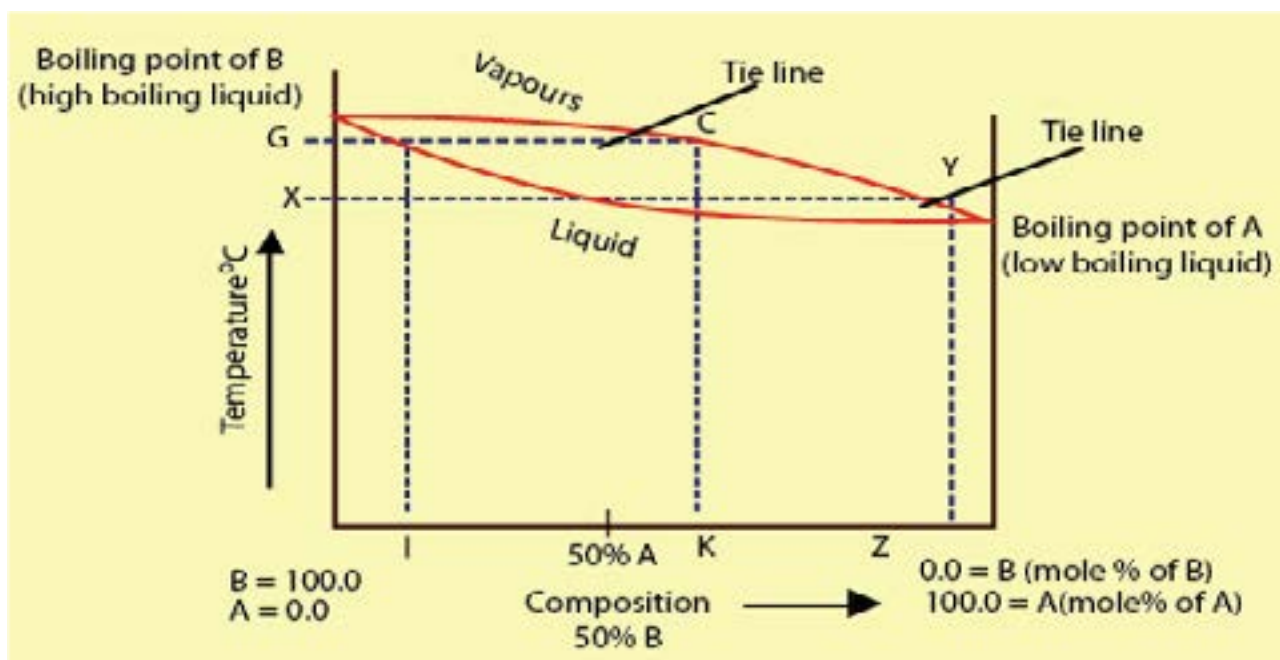

Fig (9.2) Composition - temperature curve of an ideal solution.

The upper curve represents the composition of the vapours of different solutions while the lower curve represents the composition of the liquid mixtures. The reason is that at any temperature the composition of vapours is different from the composition of liquid mixture.

Consider the temperature, corresponding to the point G. It is the boiling point of solution corresponding to composition I. It meets liquid curve at point H and the vapour curve at the point C. The composition of liquid mixture corresponding to the point H is shown by the point I. At point I the mixture has greater percentage of B and less percentage of A. While at the same temperature the vapours of the mixture have the composition K. At the point K, the percentage of A is comparatively greater than B when we compare it with composition of liquid mixture corresponding to point I. Because A is a low boiling liquid, it is present in the vapour state in greater percentage than at point I.

If the temperature of the mixture is maintained corresponding to point G, the distillate will have greater percentage of A and the residue will have greater percentage of B. The reason is that the fraction going to distillate is that which is in vapour state and it has greater % of A. The distillate of composition K is again subjected to distillation. Its boiling point is X, and at this temperature the distillate of composition Z is obtained. This distillate of composition Z is further distilled. In this way, the distillate becomes more and more rich in A and residue is more and more rich in B. So, process of distillation is repeated again and again to get the pure component A. Thus we can completely separate the components by fractional distillation. **Such liquid mixtures, which distil with a change in composition, are called zeotropic mixtures.** For example, methyl alcohol-water solution can be separated into pure components by distillation.

ii. Non-Ideal Solutions (azeotropic mixtures)

Many solutions do not behave ideally. They show deviations from Raoult's Law due to differences in their molecular structures i.e. size, shape and intermolecular forces. Formation of such solutions is accompanied by changes in volume and enthalpy. The vapour pressure deviations may be positive or negative in such solutions.

Azeotropic mixtures are those which boil at constant temperature and distil over without change in composition at any temperature like a pure chemical compound. Such mixtures can not be regarded as chemical compounds as changing the total pressure alongwith the boiling point changes their composition. Whereas, for a chemical compound, the composition remains constant over a range of temperature and pressure.

The deviations of solutions are of two types:

- (a) Positive deviations
- (b) Negative deviations

(a) Positive Deviations

If a graph is plotted between composition and vapour pressure of a solution which shows positive deviation from Raoult's law, the total vapour pressure curve rises to a maximum. The vapour pressure of some of solutions are above the vapour pressure of either of the pure components.

Let us consider the mixture of A and B components at point C in Fig (9.3). At the point C Fig (9.3), the mixture has the highest vapour pressure and, therefore, the lowest, boiling point.

On distilling this type of solution, the first fraction will be a constant boiling point mixture i.e. azeotropic mixture having a fixed composition corresponding to the maximum point. For this type of solution, it is not possible to bring about complete separation of components by fractional distillation. Ethanol-water mixture is an example of this type. It boils at 78.1°C with 4.5% water and 95.5 % alcohol. 78.1°C is lower than the boiling point of ethanol (78.5°C) and water (100°C).

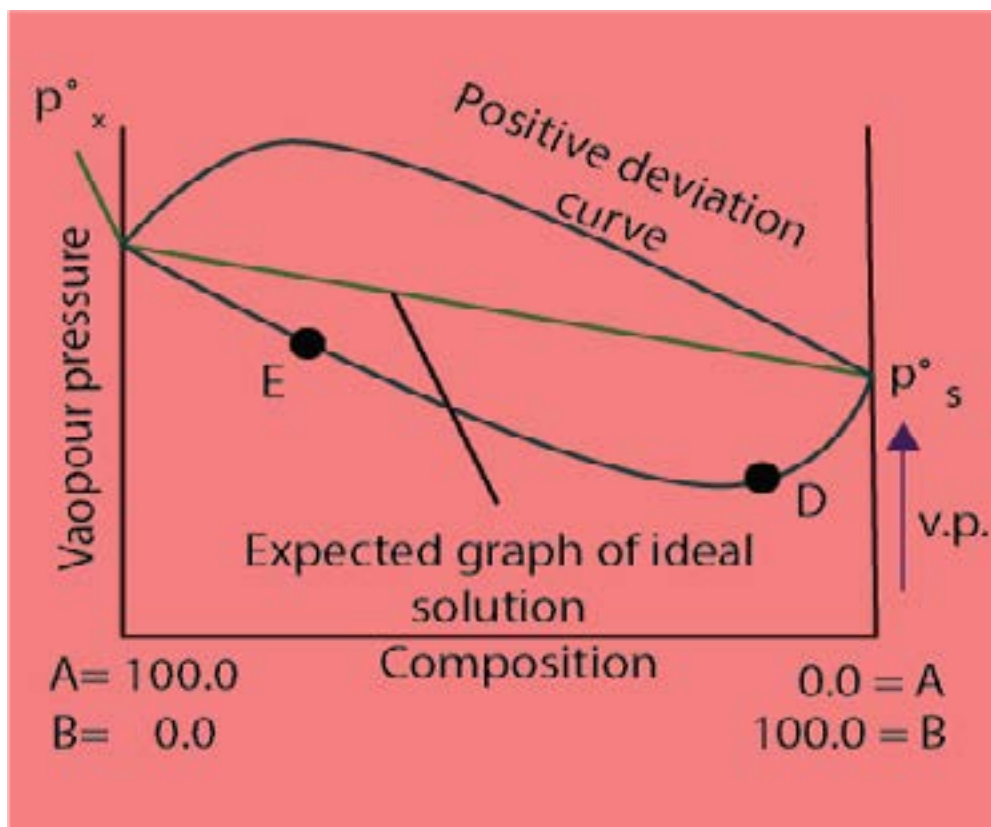

Fig (9.3) Non-ideal solutions and azeotropic mixtures for positive deviation

(b) Negative Deviations

For this type of solution, the vapour pressure curve shows a minimum. Let us consider a point E in Fig (9.3). Here, the more volatile component A is in excess. On distilling this solution, the vapours will contain more of A and the remaining mixture becomes richer in less volatile component B'. Finally, we reach the point D where vapour pressure is minimum and the boiling point is maximum. At this point, the mixture will distill over unchanged in composition.

Therefore, it is not possible to separate this type of solution completely into its components. We can give the example of hydrochloric acid solution in water for this type of solutions. HCl forms an azeotropic mixture with water, boiling at 110°C and containing 20.24% of the acid.

9.5 SOLUBILITY AND SOLUBILITY CURVES

Whenever a solid solute is put in a liquid solvent then the molecules or ions break away from the surface of the solid and pass into the solvent. These particles of solid are free to diffuse throughout the solvent to give a uniform solution. The solute and solvent molecules are constantly moving about in the solution phase because of kinetic energy possessed by them. In this way some of the particles of the solute may come back towards the solid due to collisions. These molecules or ions are entangled in its crystal lattice and get deposited on it. This is called re-crystallization or precipitation. If excess of solid is present in the solution then the rate of dissolution and rate of crystallization become equal. This is a state of dynamic equilibrium.

The concentration of the solute at equilibrium with the solution is constant for a particular solvent and at a fixed temperature. The solution thus obtained is called saturated solution of the solid substance and the concentration of this solution is termed as its solubility.

So the solubility is defined as the concentration of the solute in the solution when it is in equilibrium with the solid substance at a particular temperature.

Solubility is expressed in terms of number of grams of solute in 1000g of solvent. At a particular temperature, saturated solution of NaCl in water at 0°C contains 37.5g of NaCl in 100g of water. Similarly the solubility of CuSO_4 in water at 0°C is 14.3g/100g, while at 100°C it is 75.4g/100g.

To determine the solubility of substance, a saturated solution of a solid is prepared at a constant temperature. Then this solution is filtered. A known volume of this solution is evaporated in a china dish and from the mass of the residue, the solubility can be calculated.

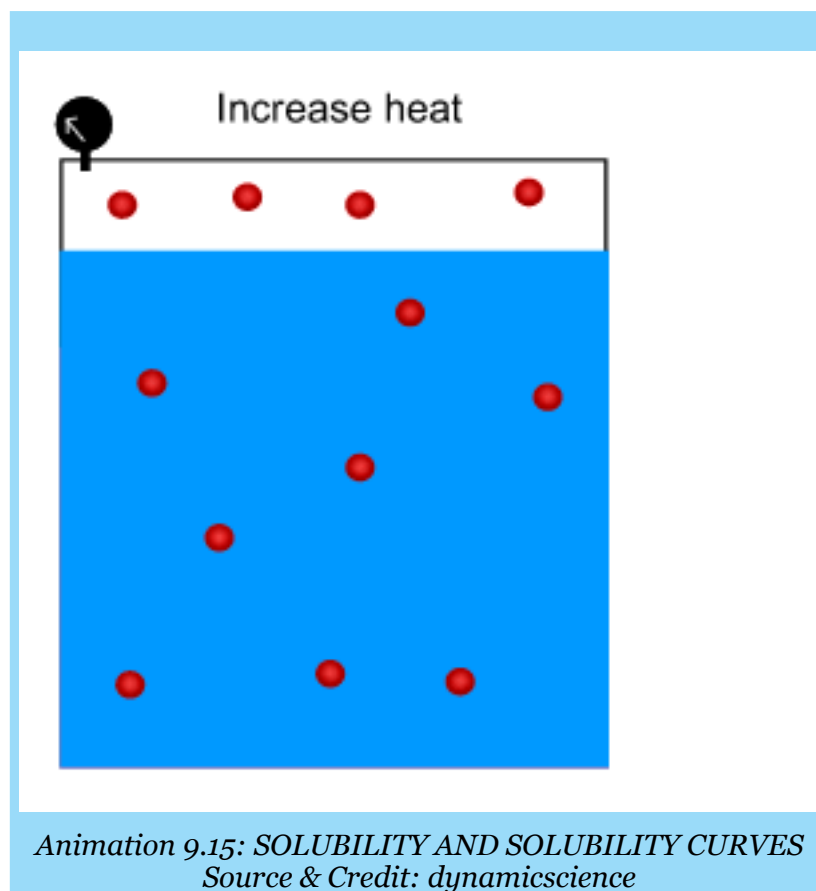

Animation 9.15: SOLUBILITY AND SOLUBILITY CURVES
Source & Credit: dynamicscience

Solubility Curves

Temperature has a marked effect on the solubility of many substances. A graphical representation between temperature and solubility of solution is called solubility curves. There are two types of solubility curves.

- Continuous solubility curves
- Discontinuous solubility curves

(a) Continuous Solubility Curves

Continuous solubility curves don't show sharp breaks anywhere. According to Fig.(9.4). KClO_3 , $\text{K}_2\text{Cr}_2\text{O}_7$, $\text{Pb}(\text{NO}_3)_2$ and CaCl_2 are showing continuous solubility curves. The solubility curves of KCl , NaCl and NaNO_3 give the straight lines. NaCl shows a very small change of solubility from 0°C to 100°C increase of temperature.

$\text{Ce}_2(\text{SO}_4)_3$ shows the exceptional behaviour whose solubility decreases with the increase in temperature and becomes constant from 40°C onwards. Anyhow, it shows continuous solubility curve.

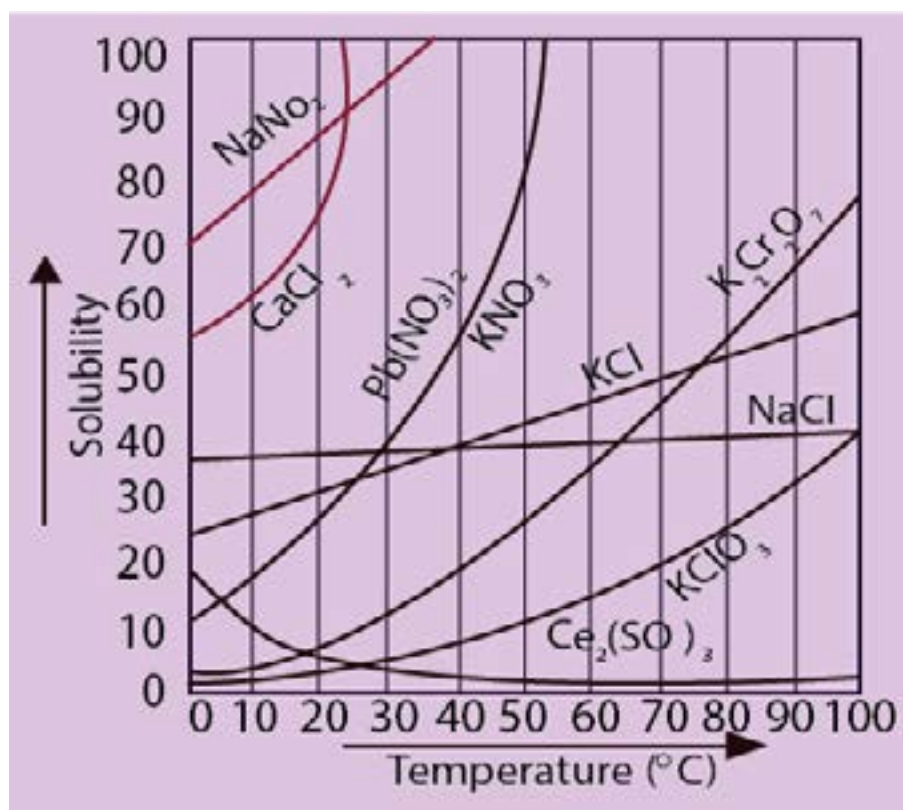

Fig (9.4) Continuous solubility curves

(b) Discontinuous Solubility Curves

Sometimes, the solubility curves show sudden changes of solubilities and these curves are called discontinuous solubility curves. The best examples in this reference are $\text{Na}_2\text{SO}_4 \cdot 10\text{H}_2\text{O}$, $\text{CaCl}_2 \cdot 6\text{H}_2\text{O}$. Actually, these curves are combination of two or more solubility curves. At the break a new solid phase appears and another solubility curve of that new phase begins. It is the number of molecules of water crystallization which changes and hence solubility changes, Fig (9.5).

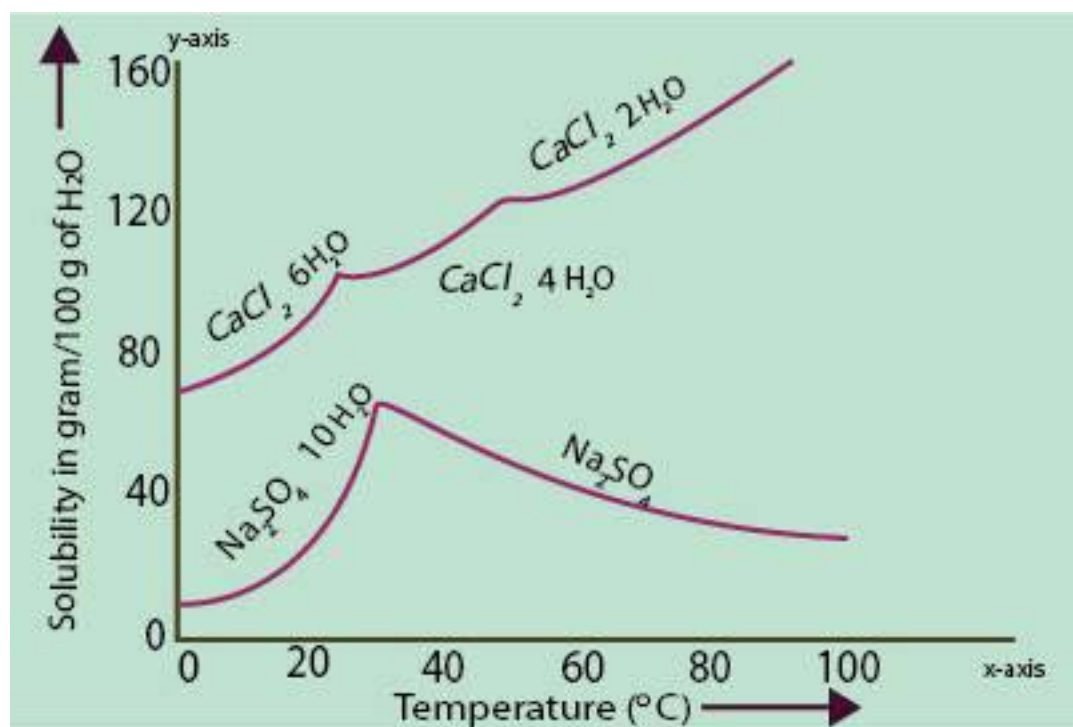
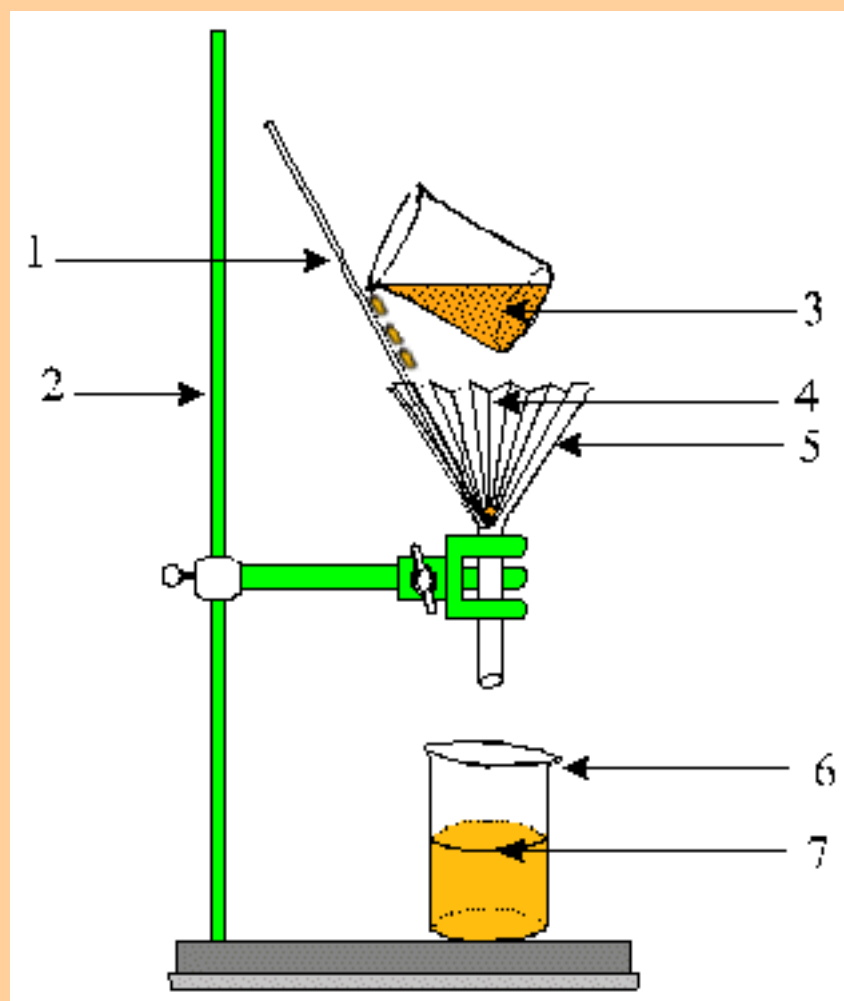

Fig (9.5) Discontinuous solubility curves

9.5.1 Fractional Crystallisation

The curves in Fig (9.4) show that the variation in solubility with temperature is different for different substances. For example, the change in solubility in case of KNO_3 is very rapid with changing temperature, while such a change is more gradual in other cases like KBr , KCl , alanine, etc. These differences in the behaviour of compounds provide the basis for fractional crystallisation, which is a technique for the separation of impurities from the chemical products.

By using the method, the impure solute is dissolved in a hot solvent in which the desired solute is less soluble than impurities. As the hot solution is cooled, the desired solute being comparatively less soluble, separates out first from the mixture, leaving impurities behind. In this way, pure desired product crystallizes out from the solution.



Animation 9.16: Fractional Crystallisation
Source & Credit: mind42

9.6 COLLIGATIVE PROPERTIES OF SOLUTIONS

The colligative properties are the properties of solution that depend on the number of solute and solvent molecules or ions. Following are colligative properties of dilute solution.

- (i) Lowering of vapour pressure
- (ii) Elevation of boiling point
- (iii) Depression of freezing point
- (iv) Osmotic pressure

The practical applications of colligative properties are numerous. The study of colligative properties has provided us with methods of molecular mass determination and has also contributed to the development of solution theory.

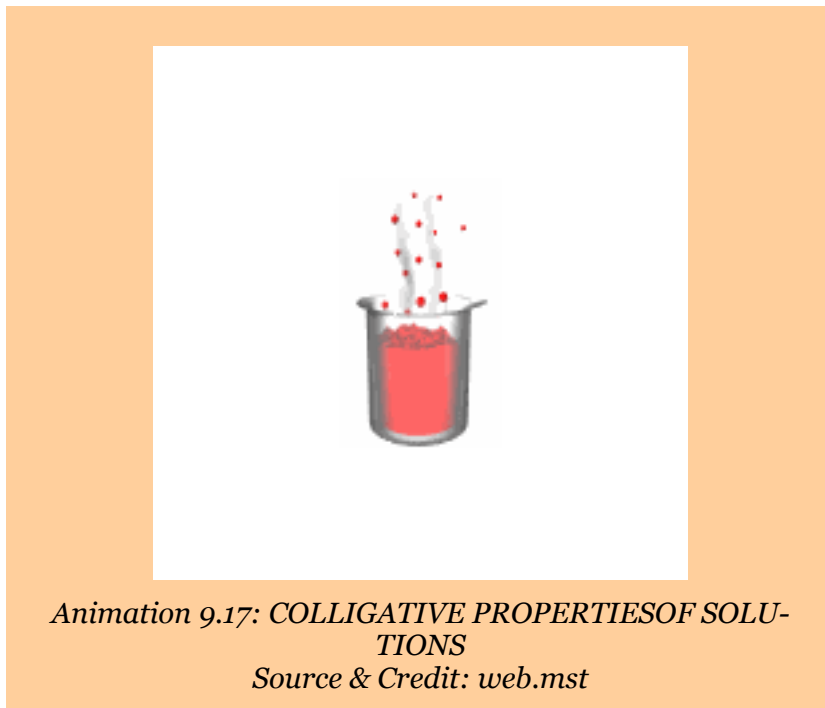

9.6.1 Why Some of the Properties are Called Colligative

The reason for these properties to be called colligative can be explained by considering three solutions. Let us take 6 g of urea, 18 g of glucose and 34.2 g of sucrose and dissolve them separately in 1 kg of H_2O .

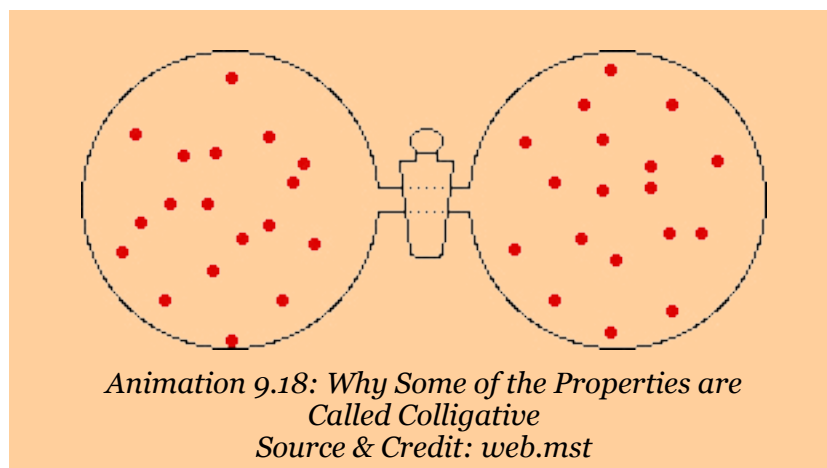

This will produce 0.1 molal solution of each substance. Pure H₂O has certain value of vapour pressure at a given temperature. In these three solutions, the vapour pressures will be lowered. The reason is that the molecules of a solute present upon the surface of a solution decrease the evaporating capability. Apparently, it seems that sucrose solution should show the maximum lowering of vapour pressure while urea should have the minimum lowering of vapour pressure. The reality is that the lowering of vapour pressure in all these solutions will be same at a given temperature. Actually, the number of particles of the solute in all the solutions are equal. We have added 1/10th of Avogadro's number of particles (6.02×10^{22}). The lowering of vapour pressure depends upon the number of solute particles and not upon their molar mass and structures. Well, it should be kept in mind that these three solutes are non-volatile and non-electrolyte.

The boiling points of these solutions are higher than that of pure solvent. It is observed that the boiling point elevation of these three solutions is 0.052 °C. Similarly, freezing points will be depressed for these solutions and the value of depression in these three cases is 0.186°C. The reason again is that the elevation of boiling point and the depression of freezing point depend upon number of particles of solute.

Now, let us deduce the values of elevation of the boiling point and the depression of the freezing point of water for 1 molal solutions. For that purpose, try to dissolve 60 g of urea, 180 g of glucose and 342 g of sugar separately in 1 kg of water. If, it is possible then the elevation of boiling point and depression of freezing point of water will be 0.52 °C and 1.86 °C, respectively. All the three solutions will boil at 100.52 °C and freeze at -1.86 °C. These values of elevation of boiling point and depression of freezing point are called molal boiling point constants and molal freezing point constants of H₂O denoted by K_b and K_f respectively.

These are also named as ebullioscopic and cryoscopic constants, respectively. These constants depend upon the nature of solvent and not upon the nature of solute. Following Table (9.3) give the values of K_b and K_f for some common solvents.

Table (9.3) K_b and K_f values for some solvents

Solvent	B.P.(°C)	K_b (°C/m)	F.P.(°C)	K_f (°C/m)
H ₂ O	100	0.52	0	1.86
Ether	34.4	2.16	-116.3	1.79
Aceticacid	118	3.07	17	3.90
Ethanol	79	1.75	-114.5	1.99
Benzene	80	2.70	5.5	5.10

To observe the colligative properties, following condition should be fulfilled by the solutions.

- (i) Solution should be dilute
- (ii) Solute should be non-volatile
- (iii) Solute should be non-electrolyte.

Now, let us discuss these colligative properties one by one. (We will not discuss osmotic pressure over here).

9.6.2 Lowering of Vapour Pressure

The particles can escape from all over the surface of a pure solvent Fig. (9.6a). When the solvent is containing dissolved non-volatile non-electrolyte solute particles, the escaping tendency of solvent particles from the surface of the solution decreases and its vapour pressure is lowered Fig (9.6 b)

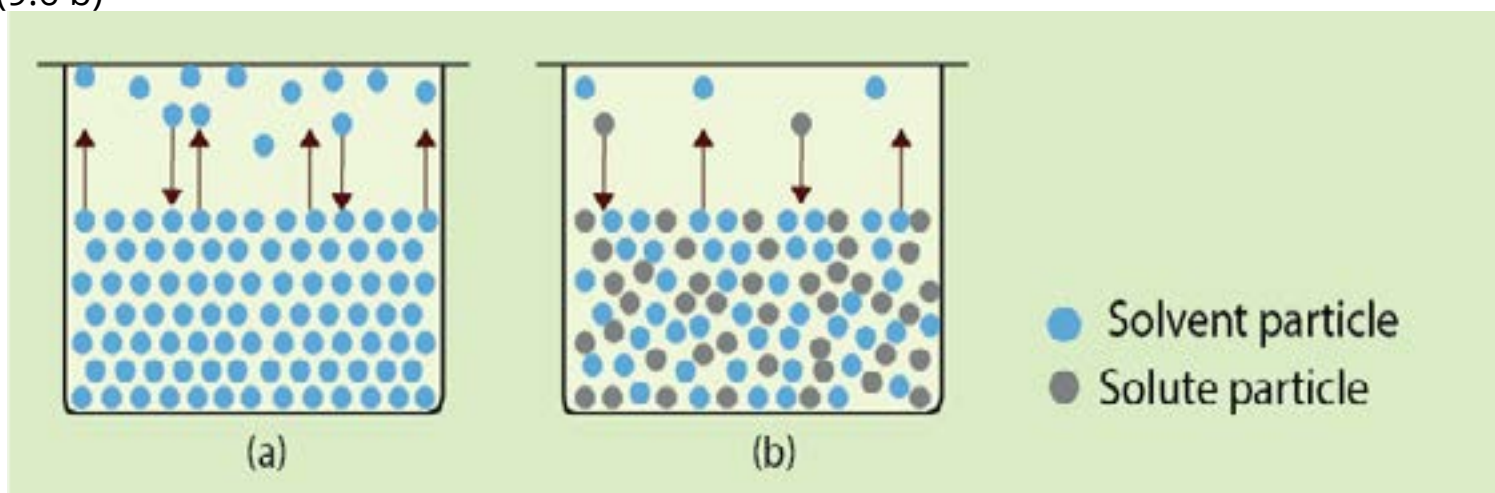

Fig (9.6) Lowering of vapour pressure

A quantitative relationship between the change of vapour pressure of a solvent due to addition of non-volatile and non-electrolyte solute and the mole fraction of solute has been given by Raoult.

According to equation (3), Raoult says that relative lowering of vapour pressure is equal to the mole fraction of solute.

$$\frac{\Delta p}{p^{\circ}} = x_2$$

If n_2 and n_1 are the number of moles of a solute and solvent respectively, then

$$x_2 = \frac{n_2}{n_1 + n_2}$$

So,
$$\frac{\Delta p}{p^\circ} = \frac{n_2}{n_1 + n_2}$$

For a dilute solution, n_2 can be ignored in denominator

Hence,
$$\frac{\Delta p}{p^\circ} = \frac{n_2}{n_1}$$

The number of moles of solute and solvent are obtained by dividing their masses in grams with their respective relative molecular masses. If W_1 and W_2 are the masses of solvent and solute while M_1 and M_2 are their relative molecular masses respectively, then

$$n_1 = \frac{W_1}{M_1} \quad \text{and} \quad n_2 = \frac{W_2}{M_2}$$

$$\frac{\Delta p}{p^\circ} = \frac{W_2}{W_1} \times \frac{M_1}{M_2}$$

$$\frac{\Delta p}{p^\circ} = \frac{W_2}{M_2} \times \frac{M_1}{W_1} \quad \dots\dots\dots (5)$$

$$M_2 = \frac{p^\circ}{\Delta p} \times \frac{W_2 M_1}{W_1} \quad \dots\dots\dots (6)$$

The molecular mass (M_2) of a non-volatile solute can be calculated from the equation (6).

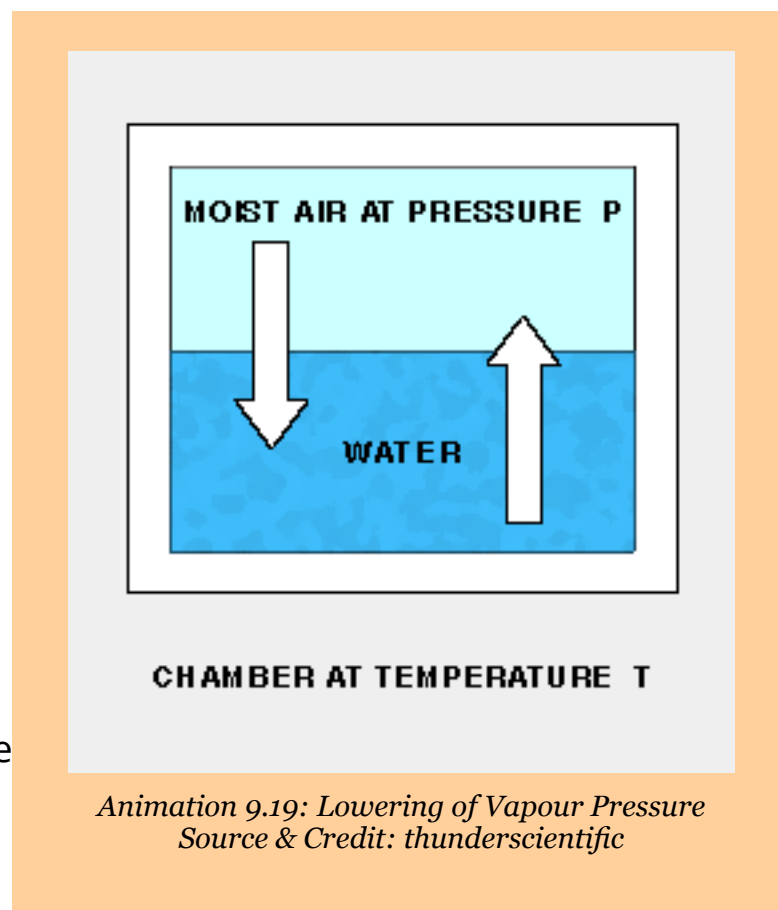

Example 10:

Pure benzene has a vapour pressure of 122.0 torr at 32°C. When 20g of a non-volatile solute were dissolved in 300g of benzene, a vapour pressure of 120 torr was observed. Calculate the molecular mass of the solute. The molecular mass of benzene being 78.1.

Solution

Let the molecular mass of the solute be	= M_2
Mass of solute dissolved (W_2)	= 20 g
Vapour pressure of pure solvent (p°)	= 122.0 torr
Vapour pressure of solution (p)	= 120.0 torr
Lowering of vapour pressure (Δp)	= 122.0 - 120.0 = 2.0 torr
Mass of solvent (W_1)	= 300 g
Molar mass of solvent (M_1)	= 78.1

Formula applied $\frac{\Delta p}{p^\circ} = \frac{W_2}{M_2} \times \frac{M_1}{W_1}$

$$M_2 = \frac{p^\circ}{\Delta p} \times \frac{W_2 M_1}{W_1}$$

Putting the values

$$M_2 = \frac{122.0}{2.0} \times \frac{20 \times 78.1}{300} = \boxed{317.6 \text{ g mol}^{-1}} \text{ Answer}$$

9.6.3 Elevation of Boiling Point

The presence of a non-volatile non-electrolyte solute in the solution decreases the vapour pressure of the solvent. Greater, the concentration of solute, greater will be the lowering of vapour pressure. Therefore, the temperature at which a solvent in the solution state boils is increased. In order to understand it, determine the vapour pressures of a solvent at various temperatures. Plot a graph between temperatures on x-axis and vapour pressures on y-axis. A rising curve is obtained with the increase of temperature. The slope of the curve at high temperature is greater, which shows that at high temperature the vapour pressure increases more rapidly. Temperature

T_1 on the curve AB which is for the pure solvent, corresponds to the boiling point of the solvent. The solvent boils when its vapour pressure becomes equal to the external pressure represented by p° .

When the solute is added in the solvent and vapour pressures are plotted vs temperatures, then a curve CD is obtained. This curve is lower than the curve AB because vapour pressures of solution are less than those of pure solvent. Solution will boil at higher temperature T_2 to equalize its pressure to p° . The difference of two boiling points gives the elevation of the boiling point ΔT_b .

The higher the concentration of solute, the greater will be the lowering

in vapour pressure of solution and hence higher will be its boiling point. So, elevation of boiling point ΔT_b is directly proportional to the molality of solution.

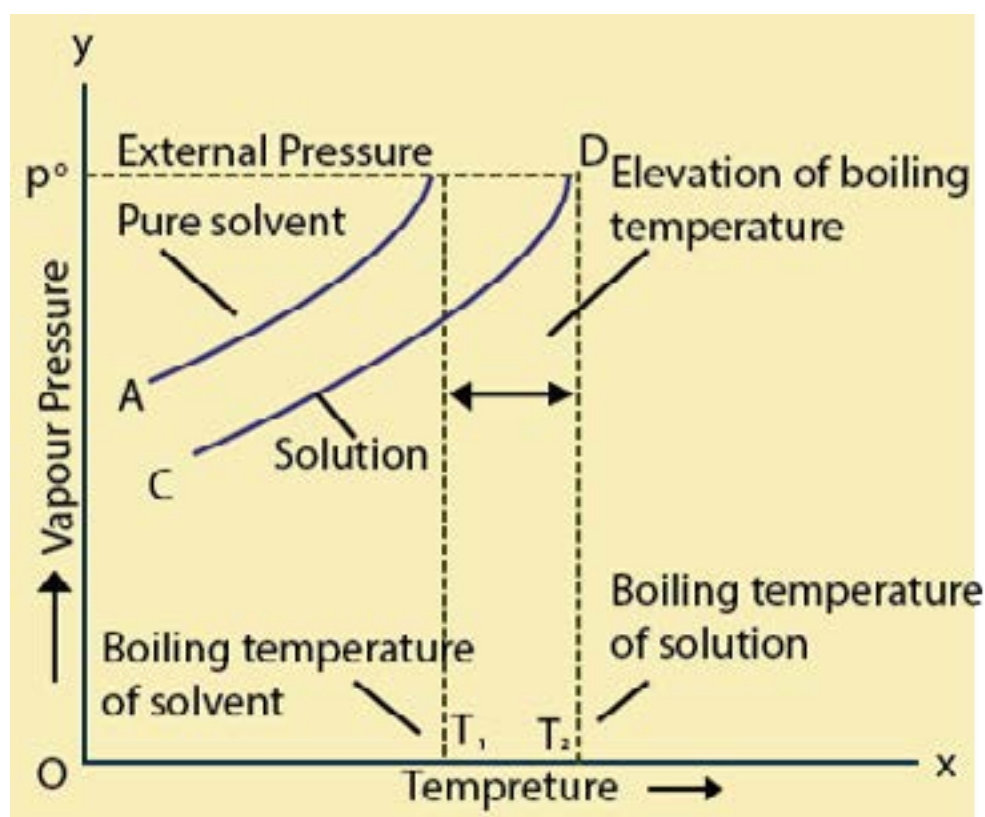

Fig (9.7) Elevation of boiling temperature curve

$$\Delta T_b = K_b m \quad \dots\dots\dots (8)$$

Where K_b is called the ebullioscopic constant or molal boiling point constant.

According to equation (8), molality of any solute determines the elevation of boiling point of a solvent. You may dissolve 6 g of urea in 500 g of H₂O or 18 g of glucose in 500 g of H₂O both give 0.2 molal solution and both have same elevation of boiling points i.e. 0.1 °C, which is 1/5th of 0.52°C. We say that ΔT_b (not T) is a colligative property. We know that

$$\text{Molality}(m) = \frac{\text{Mass of solute}}{\text{Molar mass of solute}} \times \frac{1}{\text{Mass of solvent in kg}}$$

or

$$m = \frac{W_2}{M_2} \frac{1}{W_1/1000} = \frac{1000 W_2}{M_2 W_1} \quad \dots\dots\dots (9)$$

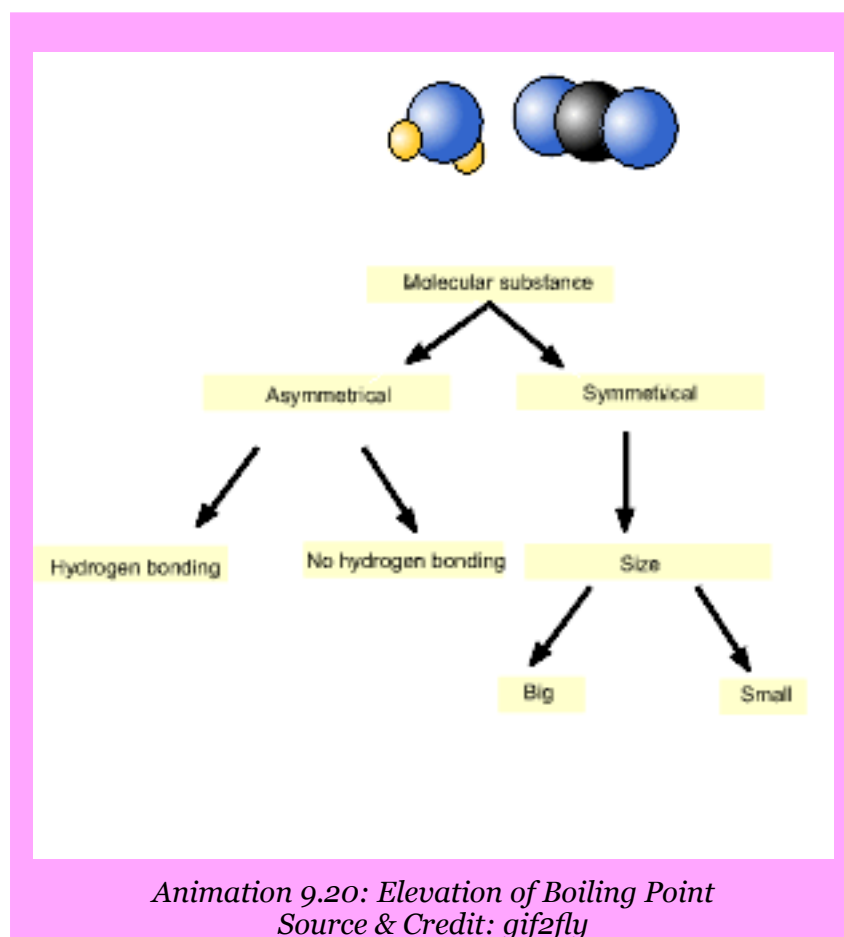

Putting the value of m from equation (9) into equation (8)

$$\Delta T_b = K_b \frac{1000 W_2}{M_2 W_1} \quad \dots\dots\dots (10)$$

Rearranging equation (10)

$$\text{Molecular mass } (M_2) = \frac{K_b}{\Delta T_b} \times \frac{W_2}{W_1} \times 1000 \quad \dots\dots\dots (11)$$

Equation (11) can be used to determine the molar mass of a non-volatile and nonelectrolyte solute in a volatile solvent.

9.6.4 Measurement of Boiling Point Elevation: Landsberger's Method

This is one of the best methods for the measurement of boiling point elevation of a solution. The apparatus consists of four major parts.

- An inner tube with a hole in its side. This tube is graduated.
- A boiling flask which sends the solvent vapours into the graduated tube through a rosehead.
- An outer tube, which receives hot solvent vapours coming from the side hole of the inner tube.
- A thermometer which can read up to 0.01K.

The solvent is placed in the inner tube. Some solvent is also taken in a separate flask and its vapours are sent into this tube. These vapours cause the solvent in the tube to boil by its latent heat of condensation. This temperature is noted which is the boiling point of the pure solvent.

The supply of the vapours is temporarily cut off and a weighed pellet of the solute is dropped in the inner tube. The vapours of the solvent are again passed through it until the solution is boiled. This temperature is again noted. Fig (9.8).

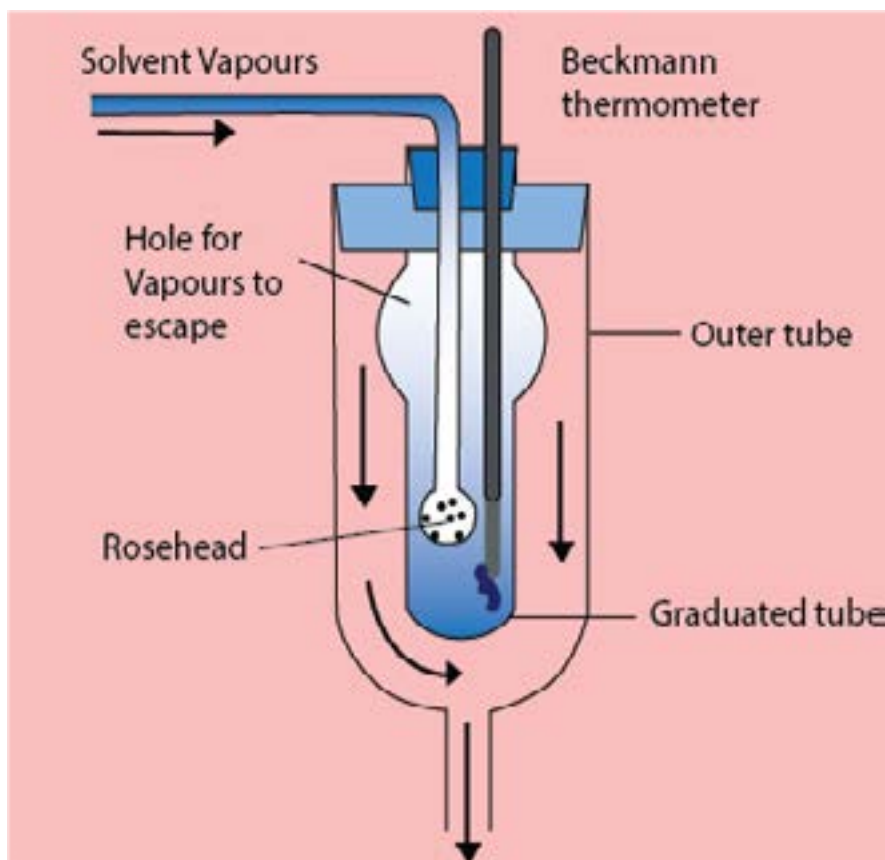

Fig (9.8) Landsberger method for measurement of elevation of boiling point

Now, the supply of the solvent vapours is cut off. The thermometer and the rosehead are removed and the volume of the solution is measured. The difference of the two boiling points gives the value of ΔT_b . The following formula is used to calculate the molecular mass of solute.

$$M_2 = \frac{K_b}{\Delta T_b} \frac{1000 W_2}{W_1} \dots\dots\dots (11)$$

Example 11:

The boiling point of water is 99.725 °C. To a sample of 600g of water are added 24.0 g of a solute having molecular mass of 58 g mol⁻¹, to form a solution. Calculate the boiling point of the solution.

Solution

Boiling point of pure H₂O = 99.725°C

Mass of solvent (H₂O) W₁ = 600 g

Mass of solute (W₂) = 24.00 g

Molar mass of solute (M₂) = 58 g mol⁻¹

The molal boiling point constant of H₂O (K_b) = 0.52°C

Formula

$$\Delta T_b = K_b \times \frac{1000 W_2}{W_1 \times M_2}$$

$$= \frac{0.52 \times 1000 \times 24.00}{600 \times 58} = 0.358^\circ\text{C}$$

Boiling point of solution = boilingpoint of pure solvent + elevation of boiling point

$$= 99.725 + 0.358 = \boxed{100.083^\circ\text{C}} \text{ Answer}$$

9.6.5 Depression of the Freezing Point of a Solvent by a Solute

The freezing point of a substance is the temperature at which the solid and liquid phases of the substance co-exist. **Freezing point is also defined as that temperature at which its solid and liquid phases have the same vapour pressures.** When a non-volatile solute is added to a solvent, its vapour pressure is decreased. At the freezing point, there are two things in the vessel i.e. liquid solution and the solid solvent. The solution will freeze at that temperature at which the vapour pressures of both liquid solution and solid solvent are same. It means that a solution should freeze at lower temperature than pure solvent.

In order to understand it, plot a graph between vapour pressure temperature for pure solvent and that of solution. The curve ABC is for the pure solvent. The solvent freezes at temperature T_1 corresponding to the point B when the vapour pressure of freezing solvent is p° . The portion of the curve BC is for the solid solvent. This portion has a greater slope, showing that the change of vapour pressure with the change of temperature is more rapid Fig (9.9).

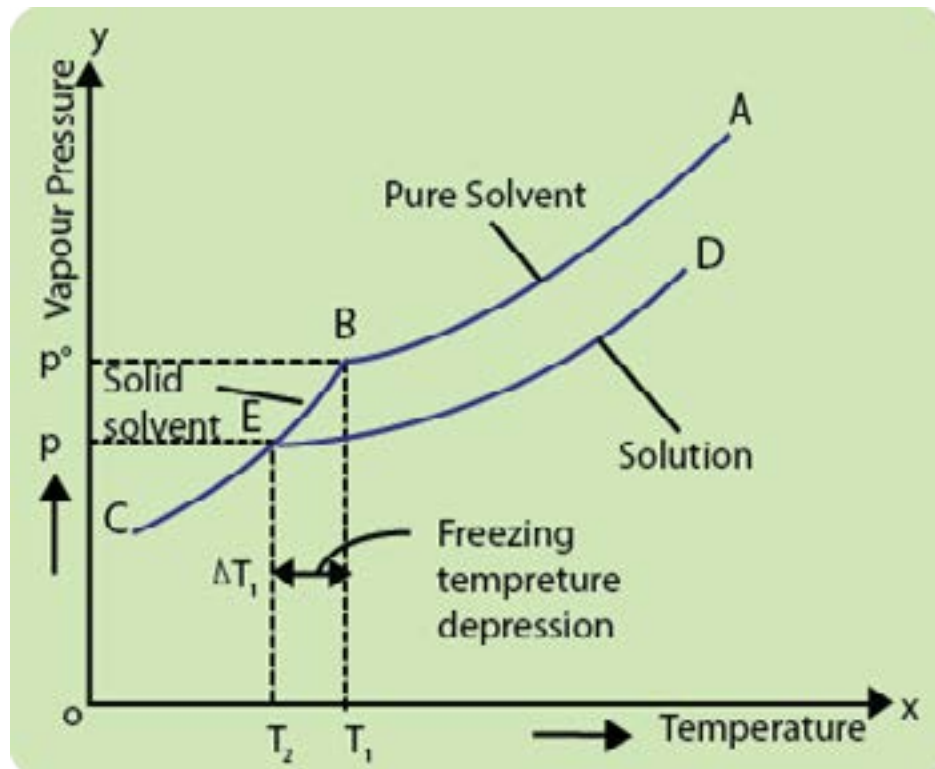
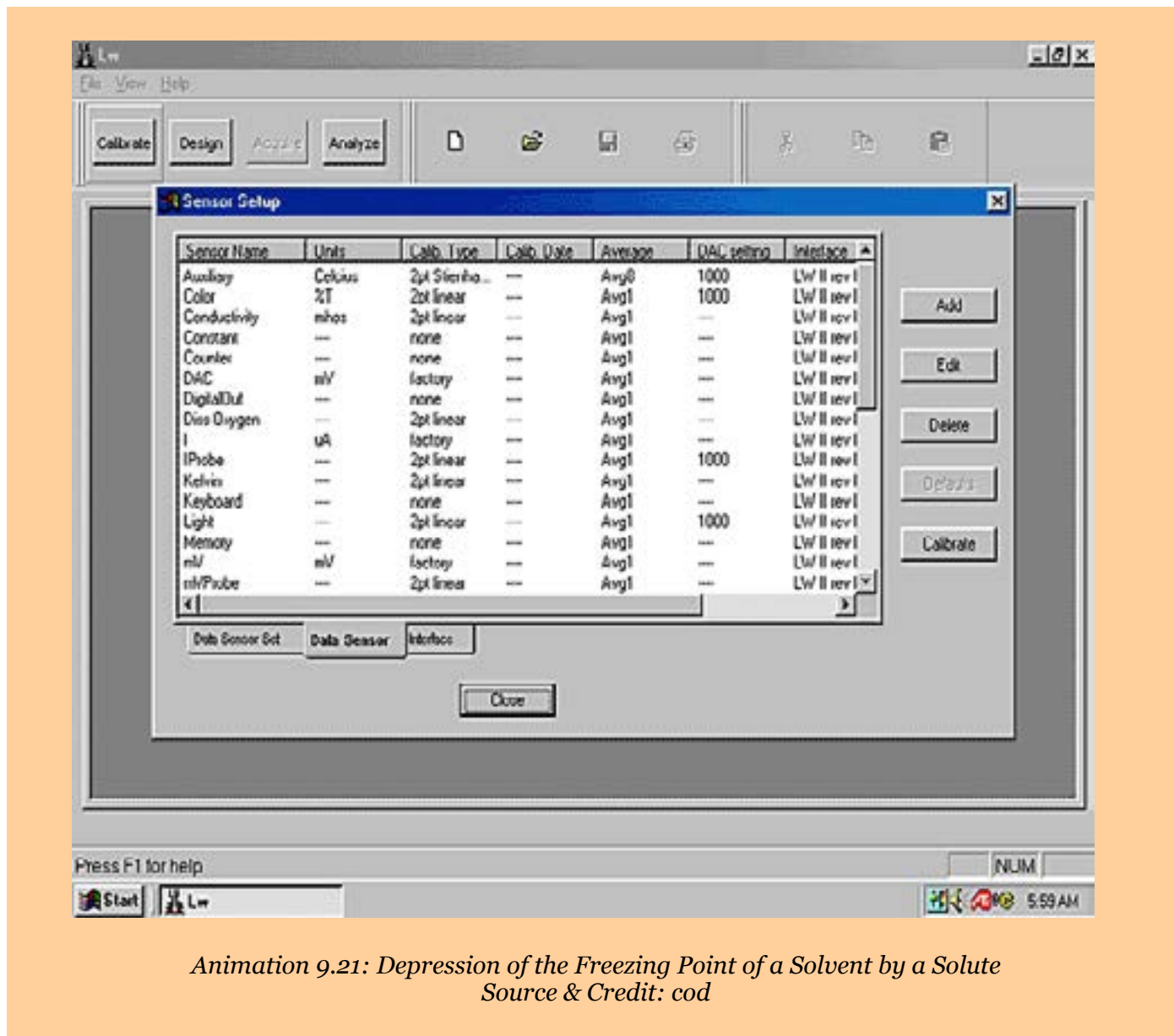

Fig (9.9) Depression of freezing point curve

The curve DEC for the solution will meet the curve BC at the point E. This is the freezing point of solution T_2 , and corresponds to the vapour pressure p which is lower than p° . The reason is that vapour pressure of solution is less than the pure solvent.



Animation 9.21: Depression of the Freezing Point of a Solvent by a Solute
Source & Credit: cod

Depression of freezing point = freezing point of pure solvent - freezing point of solution.

So, $\Delta T_f = T_1 - T_2$

This depression in freezing point ΔT_f is related to the molality (m) of the solution. The relationship is similar to that of elevation of the boiling point.

$$\Delta T_f \propto m$$

$$\Delta T_f = K_f m \quad \dots\dots\dots (12)$$

K_f is called the molal freezing point constant or the cryoscopic constant and m is the molality of the solution. To get the final expression, let us put the following expression (9) of molality into the equation (12) i.e.

$$m = \frac{1000 W_2}{M_2 \times W_1} \quad \dots\dots\dots (9)$$

We get
$$\Delta T_f = K_f \frac{1000 W_2}{M_2 \times W_1} \quad \dots\dots\dots (13)$$

Where W_2 = mass of solute and M_2 = molar mass of the solute, W_1 = mass of solvent in kg Re-arranging equation (13)

$$\text{Molar mass of solute } (M_2) = \frac{K_f}{\Delta T_f} \frac{1000 W_2}{W_1} \quad \dots\dots\dots (14)$$

9.6.6 Measurement of Freezing Point Depression Beckmann's Freezing Point Apparatus:

There are many methods but Beckmann's method is easy to perform The apparatus consists of three major parts. Fig.(9.10).

- A freezing tube with a side arm. It contains solvent or solution and is fitted with a stirrer and a Beckmann's thermometer.
- An outer larger tube into which the freezing tube is adjusted. The air jacket in between these tubes help to achieve a slower and more uniform rate of cooling.
- A large jar containing a freezing mixture. Around 20 to 25g of the solvent is taken in the freezing tube. The bulb of the thermometer, is immersed in the solvent. First of all, approximate freezing point of the solvent is measured by directly cooling the freezing point tube in the freezing mixture.

The freezing tube is then put in the air jacket and cooled slowly. In this way, accurate freezing point of the solvent is determined. Now, the solvent is re-melted by removing the tube from the bath and weighed amount of 0.2 to 0.3 g of the solute is introduced in the side tube.

The freezing point of the solution is determined while stirring the solution. The difference of the two freezing points gives the value of ΔT_f and the following formula is used to calculate the molar mass of solute.

$$M_2 = \frac{K_f}{\Delta T_f} \frac{1000 W_2}{W_1} \quad \dots\dots (14)$$

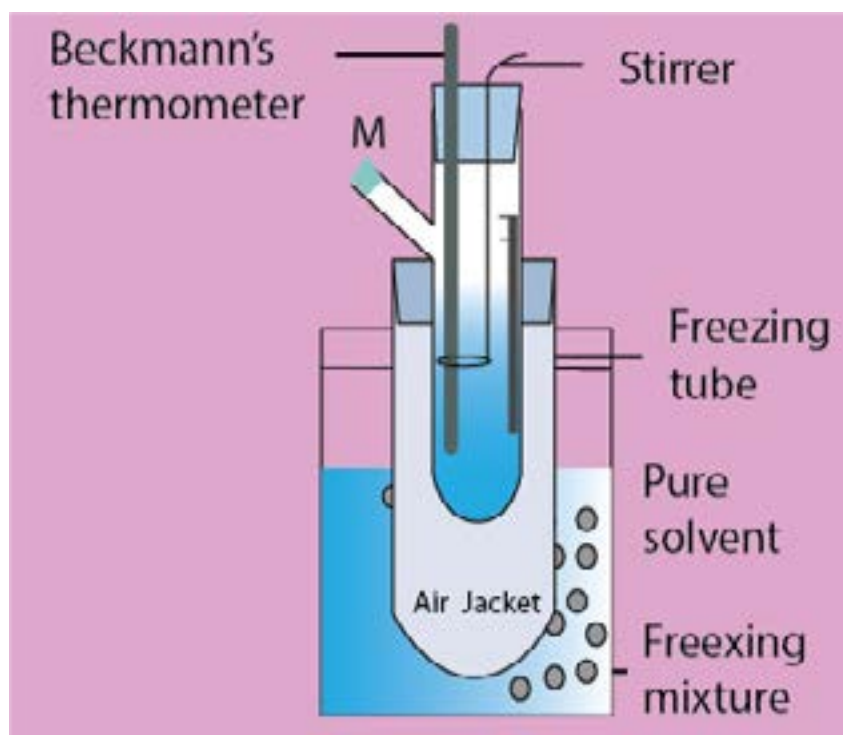

Fig (9.10) Beckmann's freezing point apparatus

Example 12:

The freezing point of pure camphor is 178.4°C . Find the freezing point of a solution containing 2.0 g of a non-volatile compound, having molecular mass 140, in 40g of camphor. The molal freezing point constant of camphor is $37.7^\circ\text{C kg mol}^{-1}$.

Solution:

Freezing point of camphor	= 178.4 °C
Mass of solute (W_2)	= 2.00g
Mass of solvent (W_1)	= 40 g
Molar mass of solute (M_2)	= 140
Molal freezing point constant of solvent	= 37.7° C kg mol ⁻¹ .
Freezing point of solution	= ?
Applying the equation	

$$\Delta T_f = K_f \frac{1000 W_2}{W_1 \times M_2}$$

We have to calculate, the freezing point of solution, so first we get the depression in freezing point ΔT_f then subtract it from freezing point of pure solvent.

$$\Delta T_f = \frac{37.7 \times 1000 \times 2}{40 \times 140} = 13.46^\circ\text{C}$$

Freezing point of solution = 178.4 - 13.4 = 164.94°C Answer

9.6.7 Applications of Boiling Point Elevation and Freezing Point Depression Phenomena

Apart from the molecular mass determination, the presence of a solute increases the liquid range of the solution both by raising the boiling point and lowering the freezing point. The most important application of this phenomenon is the use of an antifreeze in the radiator of an automobile. The solute is ethylene glycol, which is not only completely miscible with water but has a very low vapour pressure and non-volatile in character. When mixed with water, it lowers the freezing point as well as raises the boiling point.

During winter it protects a car by preventing the liquid in the radiator from freezing, as water alone, if it were used instead. In hot summer, the antifreeze solution also protects the radiator from boiling over.

Another, common application is the use of NaCl or KNO_3 to lower the melting point of ice. One can prepare a freezing mixture for use in an ice cream machine.



Animation 9.22: Applications of Boiling Point Elevation and Freezing Point Depression Phenomena
Source & Credit: lifestyle

9.7.0 ENERGETICS OF SOLUTION

In a solution, the distances between solute and solvent molecules or ions increase somewhat as compared with their pure states. This increase in the distance of solvent molecules requires energy to overcome the cohesive intermolecular forces. Hence, it is an endothermic process. Similarly, the separation of solute molecules also needs energy so it is also an endothermic process. The intermixing of solute with solvent molecules is to establish new intermolecular forces between unlike molecules. It releases energy and thus is an exothermic phenomenon. The strengths of the two type of forces will decide whether the process of dissolution will be endothermic or exothermic.

Thus, the process of dissolution occurs with either an absorption or release of energy. This is due to breakage and re-establishment of intermolecular forces of attraction between solute and solvent molecules.

When potassium nitrate is dissolved in water, the temperature of the solution decreases. It shows it to be an endothermic process. The solution of lithium chloride in water produces heat, showing that the process of dissolution is exothermic. **The quantity of heat energy, that is absorbed or released when a substance forms solution, is termed as heat of solution.**

So, the enthalpy or heat of solution of a substance is defined as the heat change when one mole of the substance is dissolved in a specified number of moles of solvent at a given temperature. It is given the symbol ΔH_{solu} . The ΔH_{solu} gives the difference between the energy possessed by the solution after its formation and the original energy of the components before their mixing i.e.

$$\Delta H_{\text{solu}} = H_{\text{solution}} - H_{\text{components}}$$

Here, ΔH_{solu} is the energy content of solution after its formation, while $H_{\text{components}}$ represents the energy contents of components before their mixing. However, both these factors can not actually be measured, only their difference i.e. the change ΔH_{solu} is practically measurable. If the value of ΔH_{solu} is negative, it would mean that the solution is having less energy than the components from which it was made, hence the dissolution process is an exothermic one. On the other hand, an endothermic process would have a positive ΔH_{solu} value. In Table (9.4) are given values of heats of solution of different ionic solids in water at infinite dilution.

Table (9.4) Heats of solution of some ionic solids

Sub-stance	Heats of solution (kJ mol ⁻¹)
NaCl	4.98
NH ₄ NO ₃	26.0
KCl	17.8
KI	21.4
NH ₄ Cl	16.2
LiCl	-35.0
Li ₂ CO ₃	-12.8

The magnitude of heat of solution gives information regarding the strength of intermolecular forces of attraction between components which mix to form a solution.

When one mole of sodium chloride (58.5g) is dissolved in 10 moles of water (180g), then 2.008 kJ of energy is absorbed.

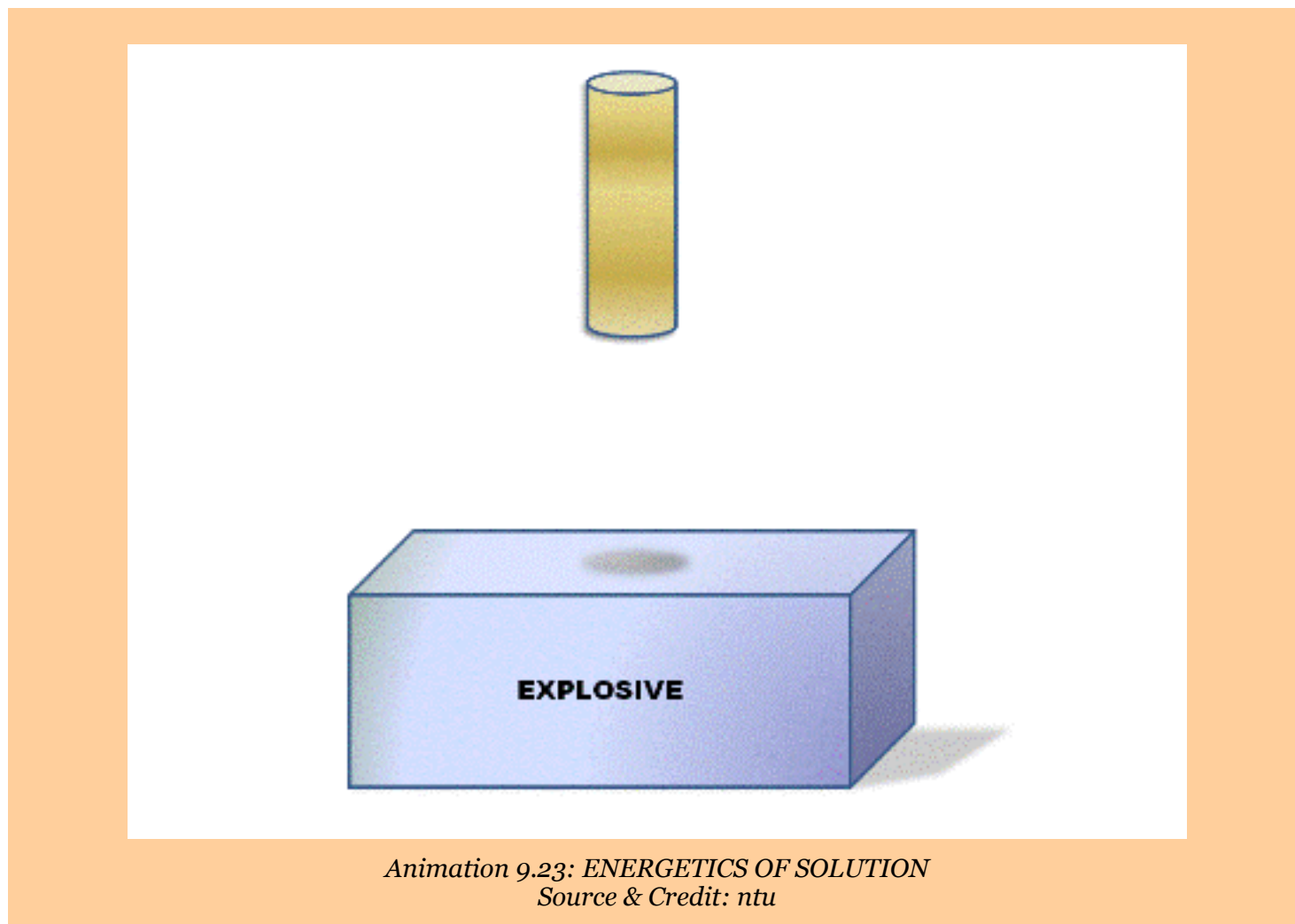
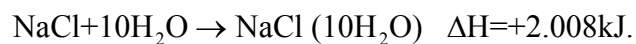

9.7.1 Hydration Energy of Ions

When an ionic compound, say potassium iodide is dissolved in water, the first step, is the separation of K^+ and I^- ions from solid. In the second step, these separated ions are surrounded by solvent molecules. The first step breaks the lattice to separate the ions.

Since, energy is required to accomplish this step, so this step is endothermic. The amount of energy needed to separate a crystalline compound into isolated ions (or atoms) is known as lattice energy. The lattice energy of ionic solids is always higher than molecular solids.

Table (9.5) Hydration energies of common ions

Ion	ΔH^0 (ionmole ⁻¹)
H ⁺	-1075
Li ⁺	-499
Na ⁺	-390
Ag ⁺	-464
K ⁺	-305
Mg ²⁺	-1891
Cu ²⁺	-1562
NH ₄ ⁺	-281
F ⁻	-457
Cl ⁻	-384
Br ⁻	-351
OH ⁻	-460

In the second step, the ions are brought into water and get hydrated (solvated) Fig (9.11). A hydrated ion is attracted by the solvent dipoles and energy is released, so this step is exothermic. The energy given out by this step is known as the hydration energy (or solvation energy).

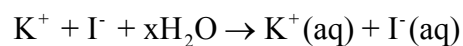

The final equation will be as follows:

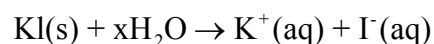

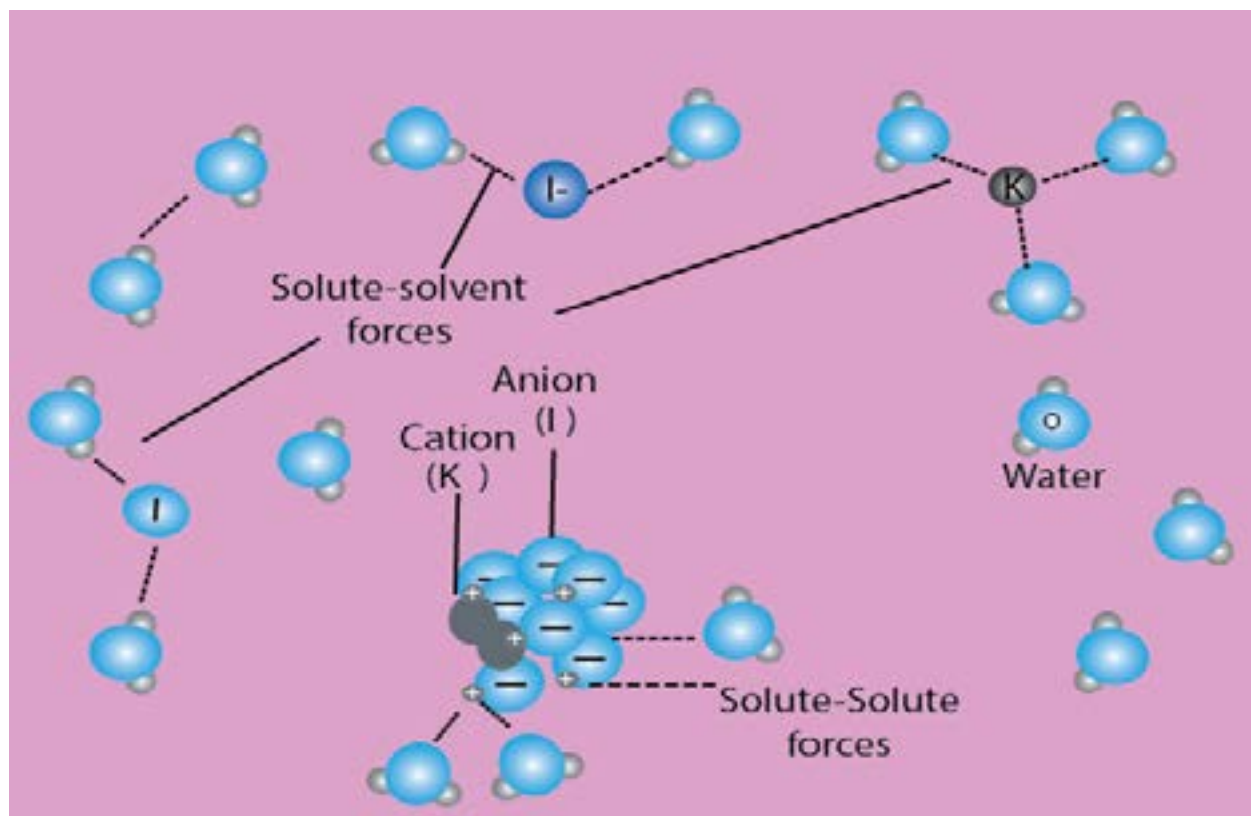
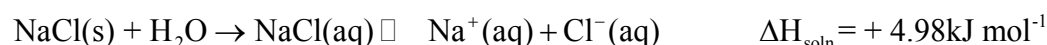
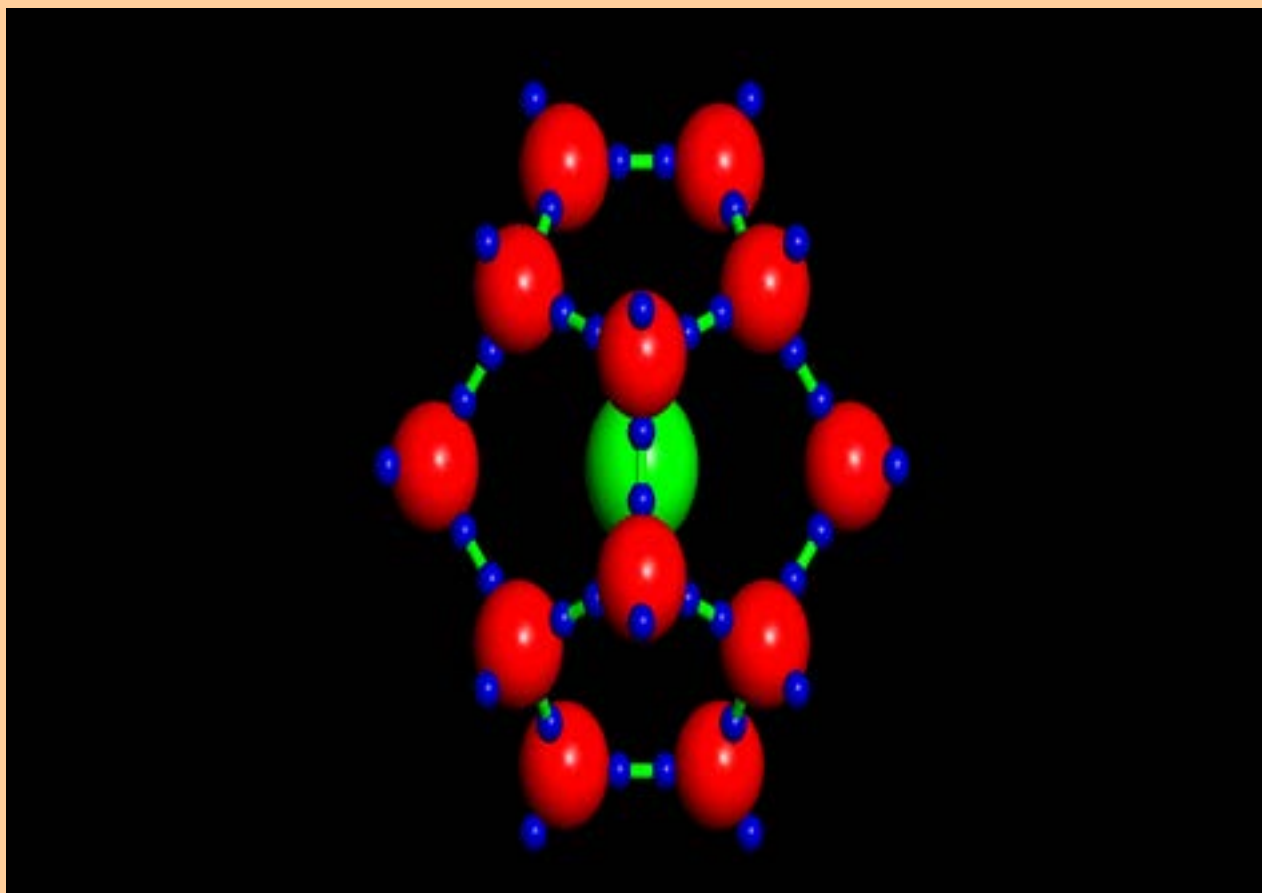

Fig (9.11) Interaction between water molecules and cations and anions provide the energy- necessary to overcome both the intermolecular forces between water molecules and the ionic bond in a potassium iodide

The values of hydration energies of individual ions, i.e. cations and anions are given in Table (9.5). It is interesting to compare these values with the ionic radii of the ions. Greater the size of monovalent cation, lesser is the heat of hydration. Divalent and trivalent cations have higher values due to high charge densities. Anions also show a definite trend of heat of hydration, depending upon their sizes.

On diluting a concentrated solution, there is a further heat change. This heat change depends on the amount of water used for dilution. The heat of dilution gradually decreases, so that eventually increasing the dilution produces no further heat change. This occurs when there are 800-1000 moles of water to one mole of solute. This stage is called infinite dilution and the heat of solution is expressed as:





*Animation 9.24: Hydration Energy of Ions
Source & Credit: arizona*

9.8 HYDRATION AND HYDROLYSIS

9.8.1 Hydration

When ionic compounds are dissolved in water, they are dissociated into ions. Negative ions are surrounded by water molecules. The partial positively charged hydrogen atoms of water surround and attract the anions with electrostatic forces of attraction. Similarly positive ions of solute create attractions with partial negative oxygen atoms of water molecules. In this way, all the ions in the aqueous solution are hydrated.

The process in which water molecules surround and interact with solute ions or molecules is called hydration.

Condensation to form a peptide bond.

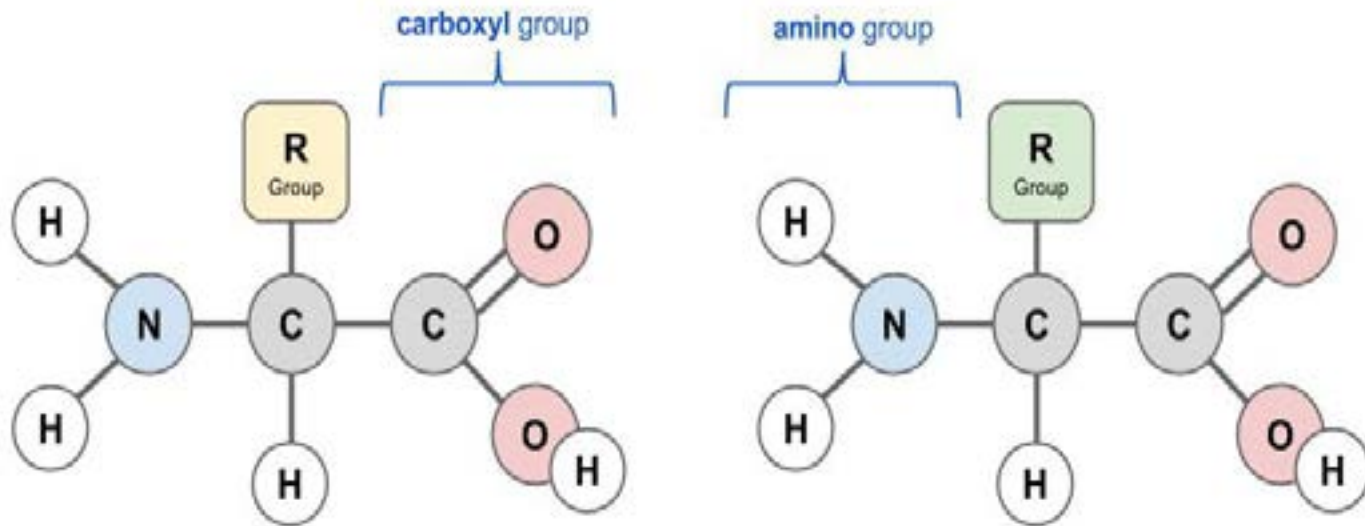

Stephen Taylor (@BiologyStephen) | Biology.net (CC)

MakeAGIF.com

Animation 9.25: HYDRATION AND HYDROLYSIS
Source & Credit: i-biology.net

The ions, which are surrounded by water molecules, are called hydrated ions. The number of water molecules, which surround a given ion depends upon the size of the ions and the magnitude of its charge (charge/area). If the size of the ion is small and is highly charged positive ion, it has high charge density. Hence, greater number of water molecules will surround it.

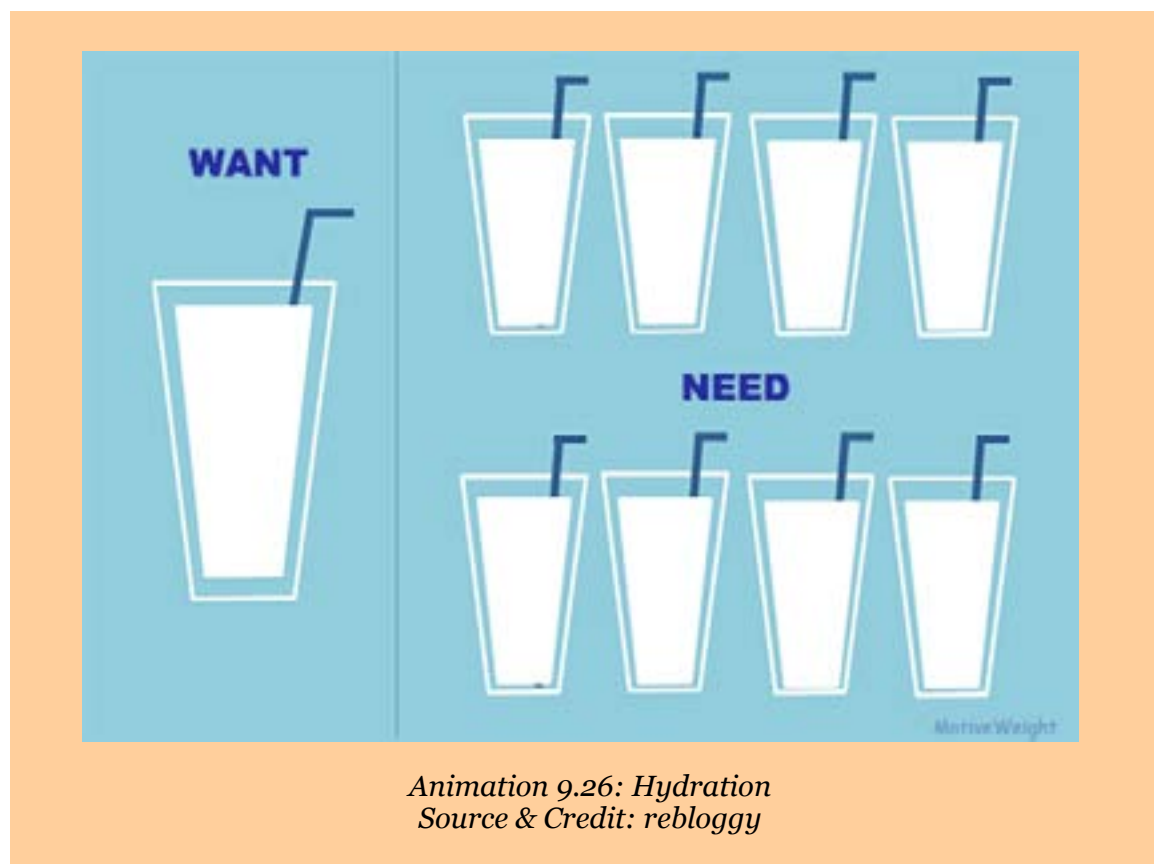

Negatively charged ions have low charge density, and have smaller number of water molecules surrounding them. Hence, the ion with high charge density has a greater ability to attract polar water molecules than ions with smaller charge density.

9.8.2 Hydrates

The crystalline substances, which contain chemically combined water in definite proportions is called a hydrate. Hydrates are mostly, produced when aqueous solution of soluble salt is evaporated. The formation of hydrates is not limited to salts but is common with acids, bases and elements. The water molecules are attached with cations in the hydrates. Anyhow, in $\text{CuSO}_4 \cdot 5\text{H}_2\text{O}$, four water molecules, are attached with Cu^{2+} and one with SO_4^{2-} . The reason is that Cu^{2+} has a greater charge density. The size of Cu^{2+} is much smaller than SO_4^{2-} , which has same amount of charge.

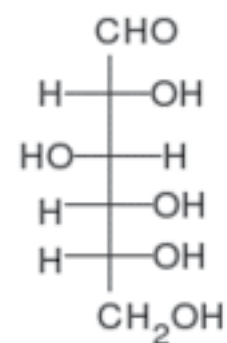

Animation 9.27: Hydrates
Source & Credit: wikipedia

Water of Crystallization

Those water molecules, which combine with substances as they are crystallized from aqueous solutions, are called water of crystallization or water of hydration. Some familiar examples are as follows: $(\text{COOH})_2 \cdot 2\text{H}_2\text{O}$ (oxalic acid), $\text{BaCl}_2 \cdot 2\text{H}_2\text{O}$, $\text{Na}_2\text{CO}_3 \cdot 10\text{H}_2\text{O}$, $\text{MgCl}_2 \cdot 6\text{H}_2\text{O}$, $\text{Na}_2\text{B}_4\text{O}_7 \cdot 10\text{H}_2\text{O}$ (borax), $\text{CaSO}_4 \cdot 2\text{H}_2\text{O}$ (gypsum), $\text{MgSO}_4 \cdot 7\text{H}_2\text{O}$ (epsom salt) and $\text{AlCl}_3 \cdot 6\text{H}_2\text{O}$.

9.8.3 Hydrolysis

When NaCl is dissolved in water, the resulting solution is neutral i.e. the concentration of each of H^+ and OH^- ions are equal to 10^{-7} M , as in pure water. But this balance between H^+ and OH^- ions can be disturbed with resulting change in the pH of solution when other salts are dissolved in water.

It is commonly observed that different salts, upon dissolving in water, do not always form neutral solutions. For example, NH_4Cl , AlCl_3 , CuSO_4 give acidic solutions in water. On the other hand, Na_2CO_3 and CH_3COONa form basic solutions in water. These interactions between salts and water are called hydrolytic reactions and the phenomenon is known as hydrolysis. It involves the reactions of the ions of different salts to give acidic or basic solutions. It is the decomposition of compounds with water, in which water itself is decomposed.

The hydrolysis of the salts mentioned above are shown as follows:

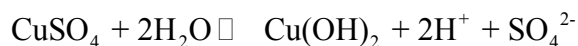
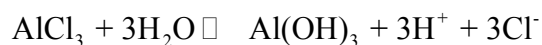

These hydrolytic reactions, produce weak bases $\text{Al}(\text{OH})_3$, NH_4OH and $\text{Cu}(\text{OH})_2$. But, Cl^- and SO_4^{2-} are weak conjugate bases of HCl and H_2SO_4 . They are not hydrolysed in water. H^+ ions remain free in solution and so their solution are acidic in character.

The K_a values of HCl and H_2SO_4 are very high as compared to K_b values of $\text{Al}(\text{OH})_3$, NH_4OH and $\text{Cu}(\text{OH})_2$. For CH_3COONa the reaction with water is



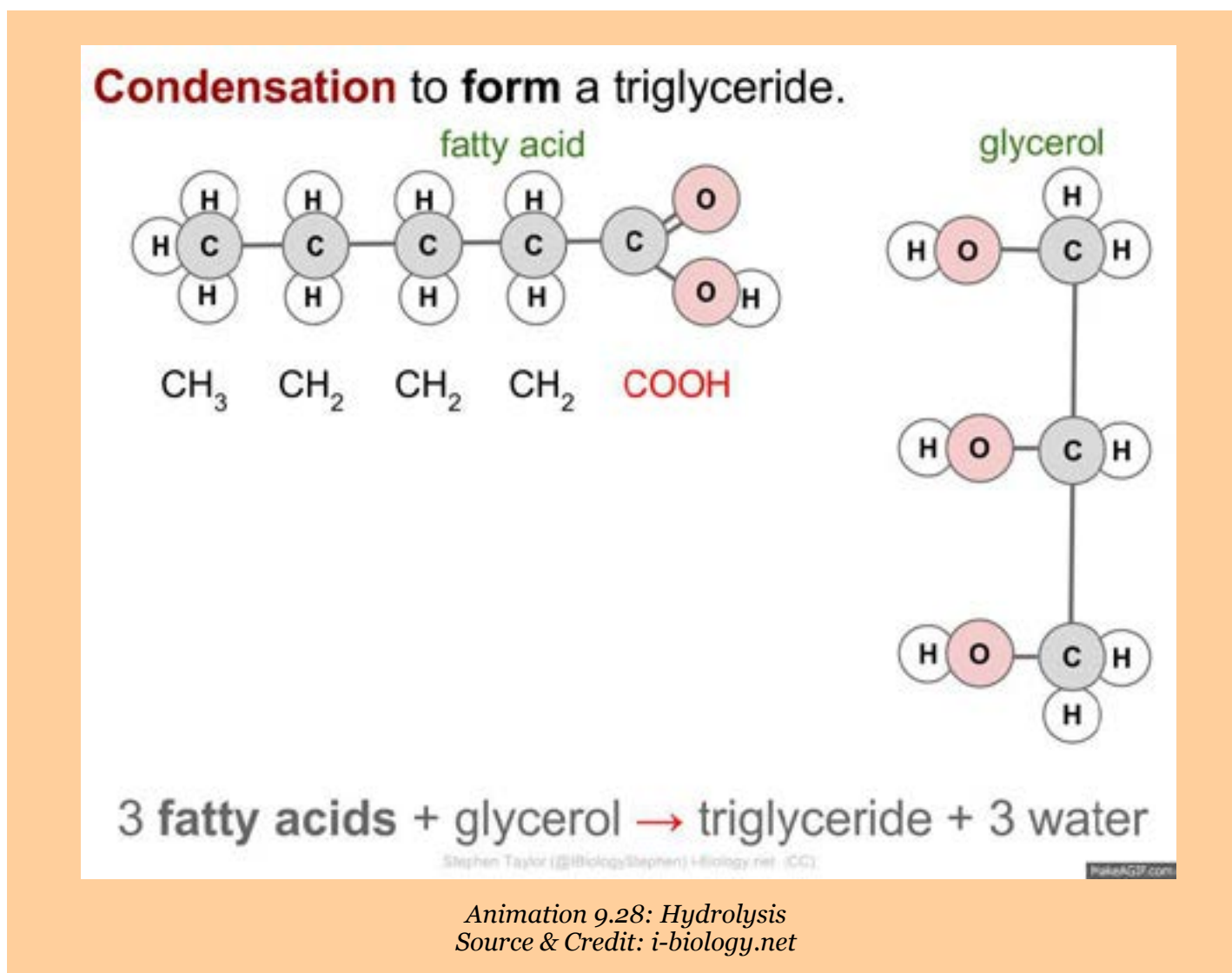

The acetate ion is hydrolyzed in water to give CH_3COOH and OH^- becomes free. Na^+ is not hydrolysed.

The result is that the solution becomes basic in nature. Similarly, Na_3PO_4 , Na_3AsO_4 etc give basic solutions in water due to the formation of a Na^+ , OH^- and weak acids Na_3PO_4 and H_3AsO_4 , which are least dissociated. The dissolution of KCl , Na_2SO_4 , KBr , etc in water give neutral solutions. Because these salts are not hydrolysed in water. Their positive ions K^+ , Na^+ are not hydrolysed by water. Similarly, their negative ions Cl^- , Br^- , SO_4^{2-} are also not hydrolysed. It means that the salts of strong bases and strong acids are not hydrolysed by water.

Anyhow, the salts derived from weak acids and weak bases may not give neutral solutions. It depends upon the pK_a and pK_b values of acid and base produced.

KEY POINTS

1. A solution, on average, is a homogeneous mixture of two or more kinds of different molecular or ionic substances. The substance, which is present in a large quantity is called a solvent and the other in small quantity is, called a solute.
2. Solutions containing relatively lower concentrations of solute are called dilute solutions, whereas those containing relatively higher concentrations of solutes are called concentrated solutions. Solubility is the concentration of a solute in a solution, when the solution is at equilibrium with the solute at a particular temperature.
3. The concentration of a solution may be expressed in a number of ways. i) percentage composition, ii) molarity, iii) molality, iv) mole fraction, v) parts per million.
4. Solutions may be ideal or non-ideal. Those solutions, which obey Raoult's law are ideal solutions. Raoult's law tells us that the lowering of vapour pressure of a solvent by a solute, at a constant temperature, is directly proportional to the concentration of solute.
5. Many solutions do not behave ideally, as they show deviations from Raoult's law. A solution may show positive or negative deviation from Raoult's law. Such liquid mixtures, which distill without change in composition, are called azeotropic mixtures.
6. Colligative properties of a solution are those properties, which depend on the number of solute and solvent molecules or ions and are independent of the nature of solute. Lowering of vapour pressure, elevation of boiling point and depression of freezing point and osmotic pressure are the important colligative properties of solutions.
7. Elevation of boiling point of a solvent in one molal solution is called molal boiling point constant or ebullioscopic constant. Depression of freezing point of a solvent in one molal solution is called molal freezing point constant or cryoscopic constant.
8. The enthalpy or heat of solution of a substance is the heat change when one mole of the substance is dissolved in a specified number of moles of solvent at a given temperature.
9. The process in which water molecules surround and interact with solute ions or molecules is called hydration. The crystalline substances, which contain molecules of water in their crystal lattices, are called hydrates. They are mostly produced, when aqueous solutions of soluble salts are evaporated.
10. Salts of weak acids with strong bases react with water to produce basic solutions, whereas salts of weak bases with strong acids react to give acidic solutions. Such reactions are called hydrolytic reactions, and the salts are said to be hydrolysed. Salts of strong acids and strong bases do not hydrolyse and give neutral solution.

EXERCISE

Q 1. Choose the correct answer for the given ones.

- i) Molarity of pure water is
(a) 1 (b) 18 (c) 55.5 (d) 6
- ii) 18 g glucose is dissolved in 90 g of water. The relative lowering of vapour pressure is equal to
(a) 1/5 (b) 5.1 (c) 1/51 (d) 6
- iii) A solution of glucose is 10% w/v. The volume in which 1 g mole of it is dissolved will be
(a) 1dm³ (b) 1.8dm³ (c) 200cm³ (d) 900cm³
- iv) An aqueous solution of ethanol in water may have vapour pressure
(a) equal to that of water (b) equal to that of ethanol
(c) more than that of water (d) less than that of water
- v) An azeotropic mixture of two liquids boils at a lower temperature than either of them when:
(a) it is saturated
(b) it shows positive deviation from Raoult's law
(c) it shows negative deviation from Raoult's law
(d) it is metastabl
- (vi) In azeotropic mixture showing positive deviation from Raoult's law, the volume of the mixture is
(a) slightly more than the total volume of the components
(b) slightly less than the total volume of the components
(c) equal to the total volume of the components
(d) none of these
- (vii) Which of the following solutions has the highest boiling'point?
(a) 5.85 % solution of sodium chloride (b) 18.0 % solution of glucose
(c) 6.0 % solution of urea (d) All have the same boiling point
- (viii) Two solutions of NaCl and KCl are prepared separately by dissolving same amount of the solute in water. Which of the following statements is true for these solutions?
(a) KCl solution will have higher boiling point than NaCl solution
(b) Both the solutions have different boiling points
(c) KCl and NaCl solutions possess same vapour pressure
(d) KCl solution possesses lower freezing point than NaCl solution

- (ix) The molal boiling point constant is the ratio of the elevation in boiling point to
- (a) molarity (b) molality
(c) mole fraction of solvent (d) mole fraction of solute
- (x) Colligative properties are the properties of
- (a) dilute solutions which behave as nearly ideal solutions
(b) concentrated solutions which behave as nearly non-ideal solutions
(c) both (i) and (ii)
(d) neither (i) nor (ii)

Q 2. Fill in the blanks with suitable words

- (i) Number of molecules of sugar in 1 dm^3 of 1M sugar solution is_____ .
- (ii) 100g of a 10% aqueous solution of NaOH contains 10g of NaOH in_____ g of water.
- (iii) When an azeotropic mixture is distilled, its _____ remains constant.
- (iv) The molal freezing point constant is also known as_____ constant.
- (v) The boiling point of an azeotropic solution of two liquids is lower than either of them because the solution shows_____ from Raoult's law.
- (vi) Among equimolal aqueous solutions of NaCl, BaCl_2 and FeCl_3 , the maximum depression in freezing point is shown by_____ solution.
- (vii) A solution of ethanol in water shows_____ deviations and gives azeotropic solution with _____ boiling point than other components.
- (viii) Colligative properties are used to calculate_____ of a compound.
- (ix) The hydration energy of Br^- ion is_____ than that of F^- ion.
- (x) The aqueous solution of NH_4Cl is_____ while that of Na_2SO_4 is_____.

Q 3. Indicate True or False from the given statements

- (i) At a definite temperature the amount of a solute in a given saturated solution is fixed.
- (ii) Polar solvents readily dissolve non-polar covalent compounds.
- (iii) The solubility of a substance decreases with increase in temperature, if the heat of a solution is negative.
- (iv) The rate of evaporation of a liquid is inversely proportional to the intermolecular forces of attraction.
- (v) The molecular mass of an electrolyte determined by lowering of vapour pressure is less than the theoretical molecular mass.
- (vi) Boiling point elevation is directly proportional to the molality of the solution and inversely proportional to boiling point of solvent.

- (vii) All solutions containing 1g of non-volatile non-electrolyte solutes in some solvent will have the same freezing point.
- (viii) The freezing point of a 0.05 molal solution of a non-volatile non-electrolyte in water is -0.93°C .
- (ix) Hydration and hydrolysis are different process for Na_2SO_4 .
- (x) The hydration energy of an ion only depends upon its charge.

Q4. Define and explain the followings with one example in each case.

- | | |
|------------------------------------|------------------------------|
| (a) A homogeneous phase | (f) Zeotropic solutions |
| (b) A concentrated solution | (g) Heat of hydration |
| (c) A solution of solid in a solid | (h) Water of crystallization |
| (d) A consolute temperature | (i) Azeotropic solution |
| (e) A non-ideal solution | (j) Conjugate solution |

- Q5. (a) What are the concentration units of solutions. Compare molar and molal solutions
- (b) One has one molal solution of NaCl and one molal solution of glucose.
- (i) Which solution has greater number of particles of solute?
- (ii) Which solution has greater amount of the solvent?
- (iii) How do we convert these concentrations into weight by weight percentage?

Q6. Explain the following with reasons

- (i) The concentration in terms of molality is independent of temperature but molarity depends upon temperature.
- (ii) The sum of mole fractions of all the components is always equal to unity for any solution.
- iii) 100 g of 98 % H_2SO_4 has a volume of 54.34 cm^3 of H_2SO_4 .(Density = 1.84 g cm^{-3})
- iv) Relative lowering of vapour pressure is independent of the temperature.
- v) Colligative properties are obeyed when the solute is non-electrolyte, and also when the solutions are dilute.
- vi) The total volume of the solution by mixing 100 cm^3 of water with 100 cm^3 of alcohol may not be equal to 200 cm^3 . Justify it.
- vii) One molal solution of urea, in water is dilute as compared to one molar solution of urea, but the number of particles of the solute is same. Justify it.
- viii) Non-ideal solutions do not obey the Raoult's law.

- Q7. What are non ideal solutions? Discuss their types and give three example of each.
- Q8.(a) Explain fractional distillation. Justify the two curves when composition is plotted against boiling point of solutions.
(b) The solutions showing positive and negative deviations cannot be fractionally distilled at their specific compositions. Explain it.
- Q9(a) What are azeotropic mixtures? Explain them with the help of graphs?
(b) Explain the effect of temperature on phenol-water system.
- Q10.(a) What are colligative properties? Why are they called so?
(b) What is the physical significance of K_b and K_f values of solvents?
- Q 11. How do you explain that the lowering of vapour pressure is a colligative property? How do we measure the molar mass of a non volatile, non- electrolyte solute in a volatile solvent?
- Q12. How do you justify that
- boiling points of the solvents increase due to the presence of solutes.
 - freezing points are depressed due to the presence of solutes.
 - the boiling point of one molal urea solution is $100.52\text{ }^\circ\text{C}$ but the boiling point of two molal urea solution is less than 101.04°C .
 - Beckmann's thermometer is used to note the depression in freezing point.
 - in summer the antifreeze solutions protect the liquid of the radiator from boiling over.
 - NaCl and KNO_3 are used to lower the melting point of ice.
- Q13. What is Raoult's law. Give its three statements. How this law can help us to understand the ideality of a solution.
- Q 14. Give graphical explanation for elevation of boiling point of a solution. Describe one method to determine the boiling point elevation of a solution.
- Q 15. Freezing points of solutions are depressed when non-volatile solutes are present in volatile solvents. Justify it. Plot a graph to elaborate your answer. Also, give one method to record the depression of freezing point of a solution.

Q16. Discuss the energetics of solution. Justify the heats of solutions as exothermic and endothermic properties.

Q17.(a) Calculate the molarity of glucose solution when 9 g of it are dissolved in 250 cm³ of solution.
(Ans: 0.2 mol dm⁻³)

(b) Calculate the mass of urea in 100 g of H₂O in 0.3 molal solution.
(Ans: 1.8g)

(c) Calculate the concentration of a solution in terms of molality, which is obtained by mixing 250 g of 20% solution of NaCl with 200 g of 40 % solution of NaCl.
(Ans: 6.94m)

Q18.(a) An aqueous solution of sucrose has been labeled as 1 molal. Find the mole fraction of the solute and the solvent.
(Ans: 0.0176, 0.9823)

(b) You are provided with 80% H₂SO₄ w/w having density 1.8 g cm⁻³. How much volume of this H₂SO₄ sample is required to obtain one dm³ of 20% w/w H₂SO₄, which has a density of 1.25 g cm⁻³.
(Ans: 173.5cm³)

Q19. 250 cm³ of 0.2 molar K₂SO₄ solution is mixed with 250 cm³ of 0.2 molar KCl solution. Calculate the molar concentration of K⁺ ions in the solution.
(Ans: 0.3 molar)

Q 20. 5g of NaCl are dissolved in 1000 g of water. The density of resulting solution is 0.997 g/cm³. Calculate molality, molarity and mole fraction of this solution. Assume that the volume of the solution is equal to that of solvent.
(Ans: M = 0.08542, m = 0.0854, Mole fraction of NaCl= 0.00154, Mole fraction of H₂O =0.9984.)

Q 21. 4.675g of a compound with empirical formula C₃H₃O were dissolved in 212.5 g of pure benzene. The freezing point of solution, was found 1.02°C less than that of pure benzene. The molal freezing point constant of benzene is 5.1°C. Calculate (i) the relative molar mass and (ii) the molecular formula of the compound.
(Ans:110gmol⁻¹, C₆H₆O₂)

Q 22. The boiling point of a solution containing 0.2 g of a substance A in 20.0 g of ether (molar mass = 74) is 0.17 K higher than that of pure ether. Calculate the molar mass of A. Molal boiling point constant of ether is 2.16 K.
(Ans: 127gmol⁻¹)

Q 23. 3 g of a non-volatile, non-electrolyte solute 'X' are dissolved in 50 g of ether (molar mass = 74) at 293 K. The vapour pressure of ether falls from 442 torr to 426 torr under these conditions. Calculate the molar mass of solute 'X'.
(Ans: 122.6 g mol⁻¹)